

Installation Manual HTC Vive Pro

Document Information:

Author: Innerspace GmbH

Revision: 1.6

Revision history:

Date	Version	Comments
2020-06-30	1.0	Initial setup of the installation manual
2020-08-24	1.1	Updated liability section, updated icons, spelling corrections
2020-10-11	1.2	Updated Japanese liability section
2021-02-22	1.3	Minor updates of all sections
2022-06-09	1.4	Minor content updates, spelling corrections, Innerspace address update
2023-04-27	1.5	Minor measure adaptations (US), Room layout update
2024-08-05	1.6	<ul style="list-style-type: none">Added disclaimer: "Innerspace recommends performing the training with a trainer."Changed document title to "Installation Manual - HTC Vive Pro"

Note:

- Innerspace instructs to read the Installation Manual before starting any tasks of the installation.
- This Installation Manual is an Innerspace original installation instruction. Innerspace GmbH holds the copyright of this document. Errors and changes excepted.

1 Contents

1	CONTENTS	2
2	INTRODUCTION.....	3
3	HEALTH AND SAFETY	4
4	PREREQUISITES	5
5	EQUIPMENT	6
6	ROOM PREPARATION.....	11
7	INSTALLING THE PRIMARY EQUIPMENT.....	19
8	STARTING THE EQUIPMENT.....	28
9	TROUBLESHOOTING AND FAQs.....	37
10	APPENDIX	40

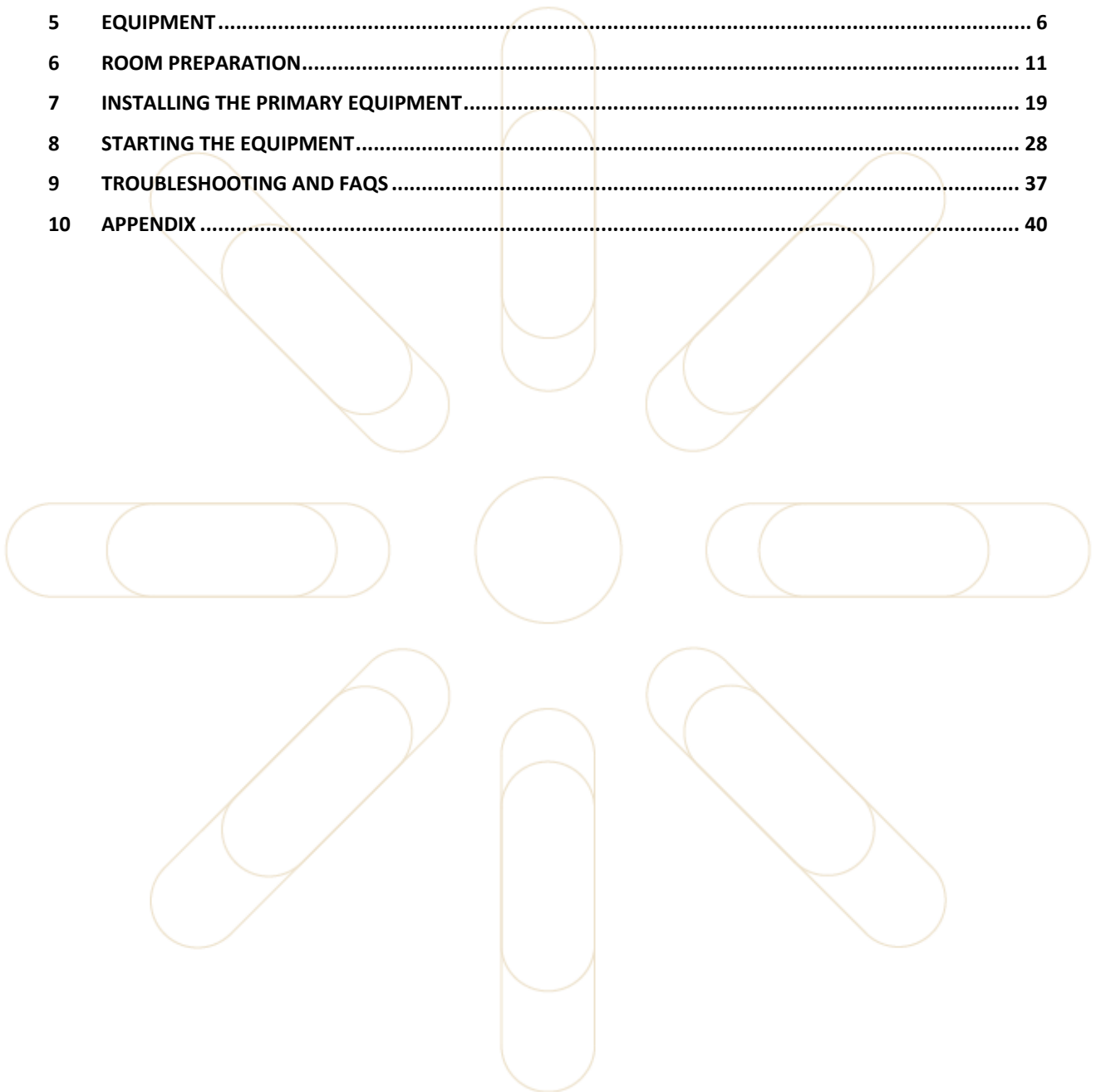

2 Introduction

The purpose of this document is to guide users through the process of installing the hardware that has been received from Innerspace. Once complete, users can successfully start a virtual reality training session. This manual is only available in digital form and not in printed form.

The document contains the following sections:

- Health and Safety
- Prerequisites
- Equipment
- Room Preparation
- Installing the Equipment
- Starting the Equipment
- Troubleshooting

Each section contains detailed information on what actions are required by the reader of this document and users of the equipment. A checklist can also be found at the end of each of these sections where relevant. This can be used to check that all the required actions have been taken.



Notice

A blue box indicates a general note. Information is provided on what to do in a specific situation.

3 Health and Safety

Ensure that the following safety and regulatory guides are reviewed, and that all-important safety information is understood before proceeding with the installation.

1. VIVE PRO safety and regulatory guide
2. Base station safety and regulatory guide

Before using the product, carefully review VIVE safety information and follow all product safety and operating instructions on <https://enterprise.vive.com/legal/>.

Notice



- Innerspace recommends performing the training with a trainer.
- The trainer should always observe the trainee.
- The training area must always be free of objects during a training session.

3.1 Limitation of Liability

Each party shall be fully liable for intent and gross negligence as well as for damages resulting from injury to life, body, or health. In case of ordinary or slight negligence, each party shall be liable only for breaches of a material contractual obligation. To the extent permitted by law: (i) no party shall be liable for any lack of commercial success, lost profits, and indirect damages and (ii) liability in accordance with the above clauses shall be limited to the typical, foreseeable damages.

3.2 Liability for External Links

The contents of this document contain links to external websites over which Innerspace has no control. Therefore, Innerspace does not accept responsibility for their content. The respective provider or operator of the external sites is responsible for their content. The linked sites were checked at the time of linking. Further, Innerspace is not responsible for the availability of the external sites or their contents.

3.3 Liability for Product Information from Third Parties

Innerspace provides product information from third parties, this product information is based on the inventory data of the third parties. Innerspace disclaims any warranty or liability for third-party product information. The user is explicitly responsible to ensure intended use only as stated by the manufacturer on <https://enterprise.vive.com/legal/>.

Notice



- For general liability information in more languages see 10 Appendix – [Exclusion of Liability](#).

4 Prerequisites

Ensure that the following prerequisites are met:

- The health and safety guides have been reviewed and understood.
- A suitable room that meets all of the Innerspace Room Requirements has been allocated for the setup of the hardware.
- The Innerspace IT Requirements have been reviewed and accepted.
- The hardware delivery has been received from Innerspace.
- **Facility and IT technicians are available** to assist with the tasks that require special attention, for example:
 - Drilling holes into walls of your room to mount some hardware on these walls
 - Setting up the hardware
 - Connecting the Innerspace workstation to the internet

Notice



Electrotechnical work has to be carried out by a qualified person specialized in electrical engineering / electronics. Mechanical work has to be carried out by a qualified person specialized in mechanics.



Checklist:

Task	Task Complete?
A suitable room has been allocated for the setup of the hardware.	
Hardware delivery received from Innerspace.	
Technicians are available when required.	

5 Equipment

5.1 Receiving the Equipment

The delivery of the equipment will be categorized as follows:

	<p>Package Main box that is received from the courier.</p>
	<p>Package Contents Boxes that are found inside the package.</p>
	<p>Box Contents Items and accessories that are found in each box.</p>

5.2 Checking the Packages and Box Content

Notice



All equipment will have been tested before being sent for delivery. Therefore, the packaging will have been opened and re-sealed. There is no reason to be concerned if it appears that one or more of the items are not sealed correctly.

Use the following checklist to confirm that all items have been received.

Notice



The delivery from Innerspace will contain either 1 set or 2 sets of equipment, depending on the order that has been placed. The second set of equipment is to be kept as a backup in case there is a problem with the primary set of equipment. If only one set has been ordered ignore the Set 2 Received column below.

If any boxes are missing contact Innerspace support to discuss further.

Package	Content	Quantity	Set 1 Received	Set 2 Received
	Base station	2		
	Base station power adapter	2		
	Base station mounting kit	2		
	Additional base station mounting kit for Wi-Fi sensor	1		
	Link box	1		
	USB 3.0 cable (marked as L1)	1		
	DisplayPort cable (marked as L2)	1		
	Link box power adapter	1		
	Link box mounting pad	1		
	HTC QC 3.0 power bank	1		
	Power bank (already mounted in Power bank holder)	1		
	Power bank connection cable (73H00690-00M)	1		
	Power bank charging cable (73H00649-00M)	1		
	Earphone hole cap	2		
	Headset with headset cable + wireless adapter attached	1		
	Cleaning cloth	1		
	Documentation	1		
	Headset cable (only needed for wired connection)	1		
	Controller (with lanyard)	2		
	Power adapter	2		
	Micro-USB cable	2		
Dell Workstation	Workstation	1		

	AC power cord	1		
	WiFi USB dongle (already mounted on the workstation)	1		
	Bluetooth dongle (already mounted on the workstation)	1		
Dell Monitor	Monitor	1		
	USB Type-C™ to A cable	1		
	AC power cord	1		
	DisplayPort™ 1.2 cable	1		
HTC VIVE Wireless Adapter	Wireless link box	1		
	Wireless link box clip	1		
	Base station mounting kit (attached to the wireless adapter box)	1		
HTC QC 3.0 Power bank (additional)	Power bank	1		
	Power bank charging cable	1		
Logitech Keyboard and Mouse	Wireless keyboard	1		
	Wireless mouse	1		
	USB charging cable	1		
USB Charger	4 port USB charger (standard with US plug)	1		
	EU plug adapter (order specific)	1		
	UK plug adapter (order specific)	1		
Sharkoon Gaming Mouse Mat (M)	Mat (M)	1		
Sharkoon Gaming Mouse Mat (XXL)	Mat (XXL)	1		
Lens Cleaning	Lens Cleaning Pen	1		

L&R Disinfection Wipes	Non-alcoholic wipes	2		
VR Cover Face Masks	Disposable face masks à 100 pcs	5		
Country specific connectors (only outside EU)	HTC VIVE Base Station Power adapter	2		
	HTC VIVE Linkbox Power adapter	1		
	AC power cord (packed with corresponding item)	2		

5.3 Review of the Manuals

Ensure that the manuals of the equipment contained in the packages have been read and understood before proceeding. The user guides can also be found online see references [1] [2] [3] [4].

5.4 Checklist

Step	Task	Task Complete?
Receiving the Equipment	Checked that all packages have been received.	
Checking the Packages and the Box Content	Checked that all items are present.	
Review of the Manuals	Read package specific product manuals.	

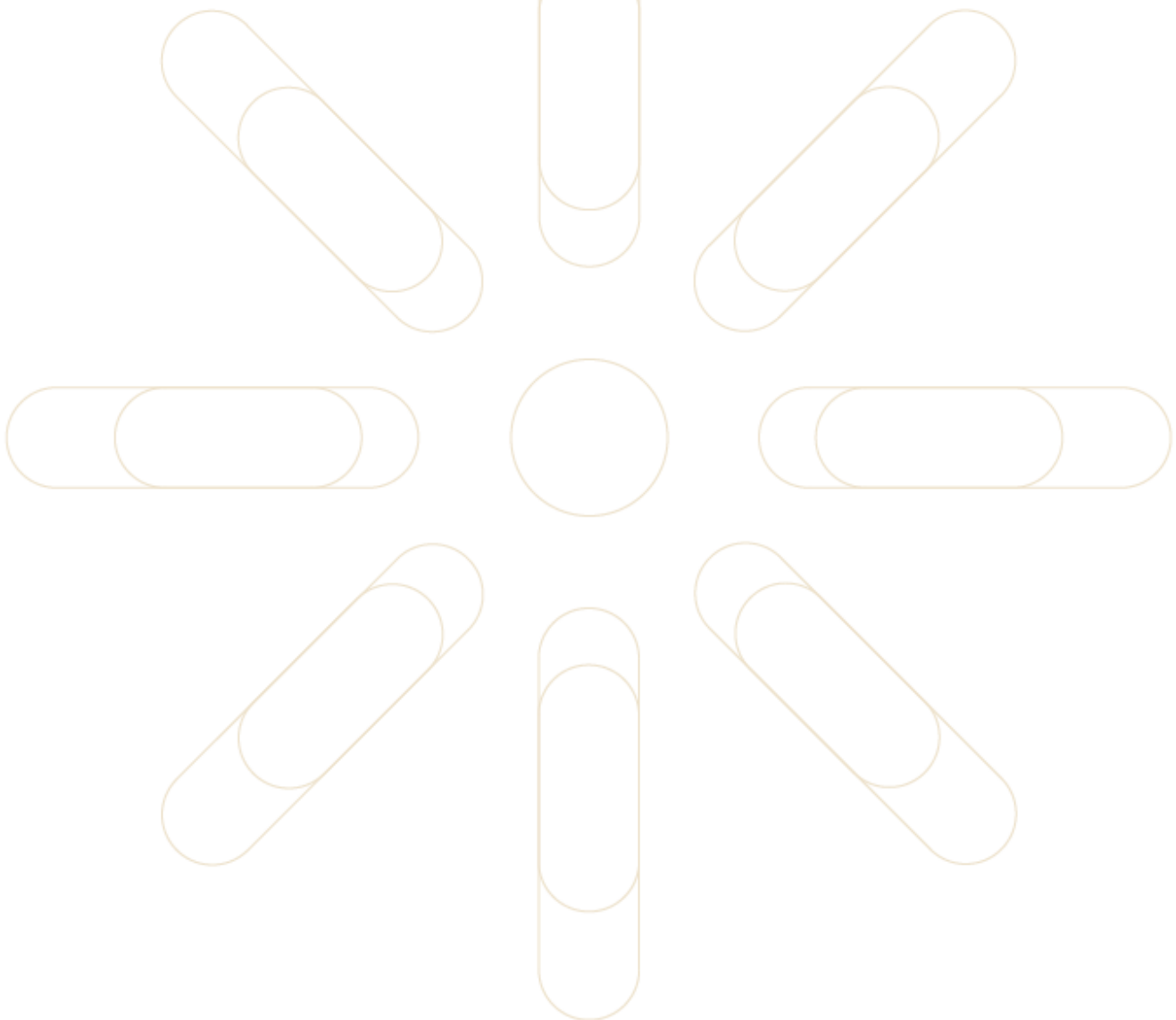

6 Room Preparation



Notice

Ensure that the following tasks are done by a facility and IT technician who are suitably trained and authorized in their profession.

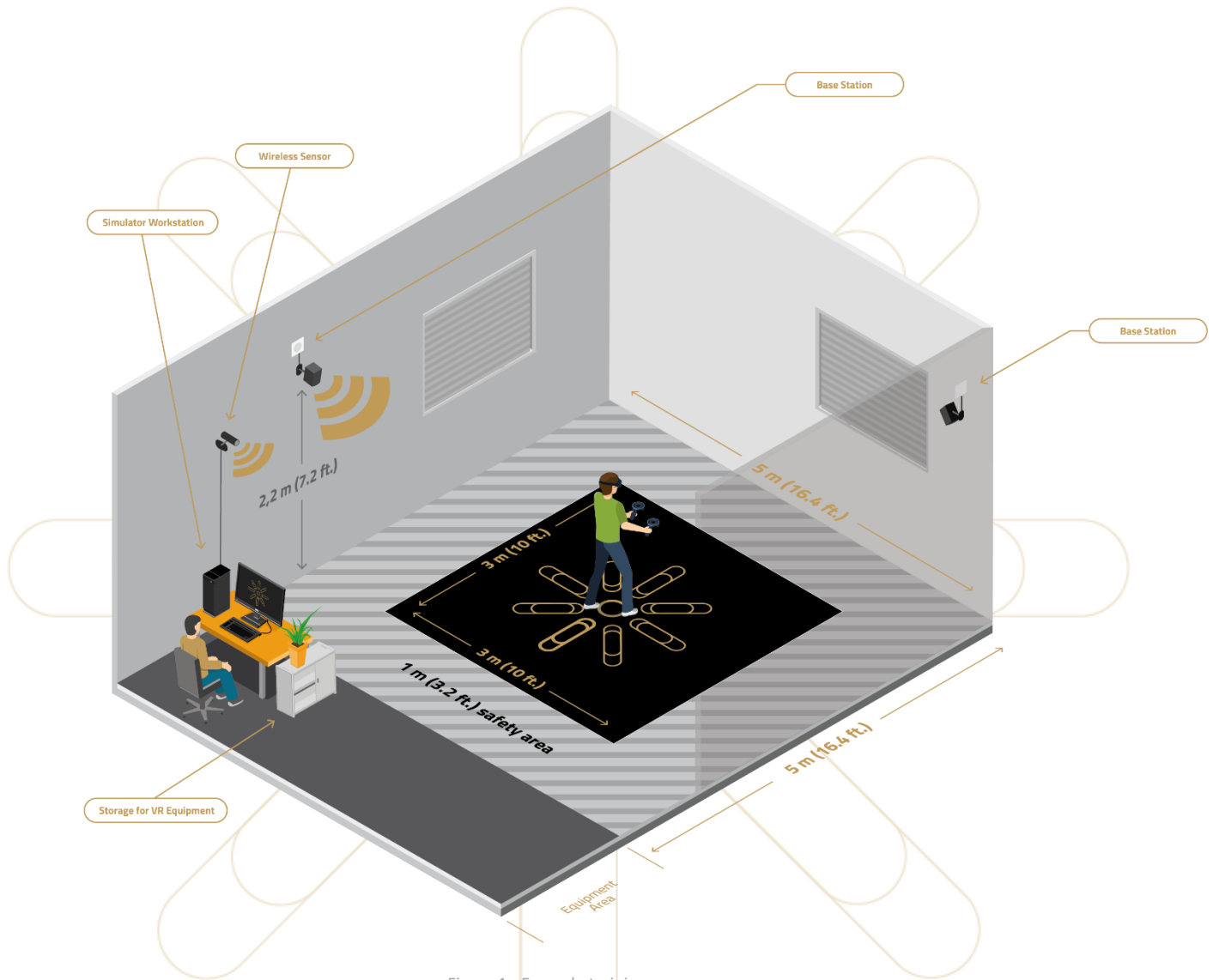

Figure 1 - Example training room

The training area must have a dimension of minimum 3 m (10 ft.) by 3 m (10 ft.) and maximum 4 m (13 ft.) by 4 m (13 ft.). There must be a 1 m (3.2 ft.) safety area surrounding the training area, to ensure the safety of the trainee.

6.1 Setting Up the Equipment Area

The virtual reality training sessions are all started from the Innerspace workstation. A desk is therefore required to correctly set up all the equipment. The position of the desk and the workstation on the desk should be agreed upon at this stage. This needs to be decided before proceeding with section 6.2.

As shown in the diagram above, this hardware should be placed outside of the virtual reality play and safety area and near a power supply.

6.2 Drilling Holes to Mount Equipment

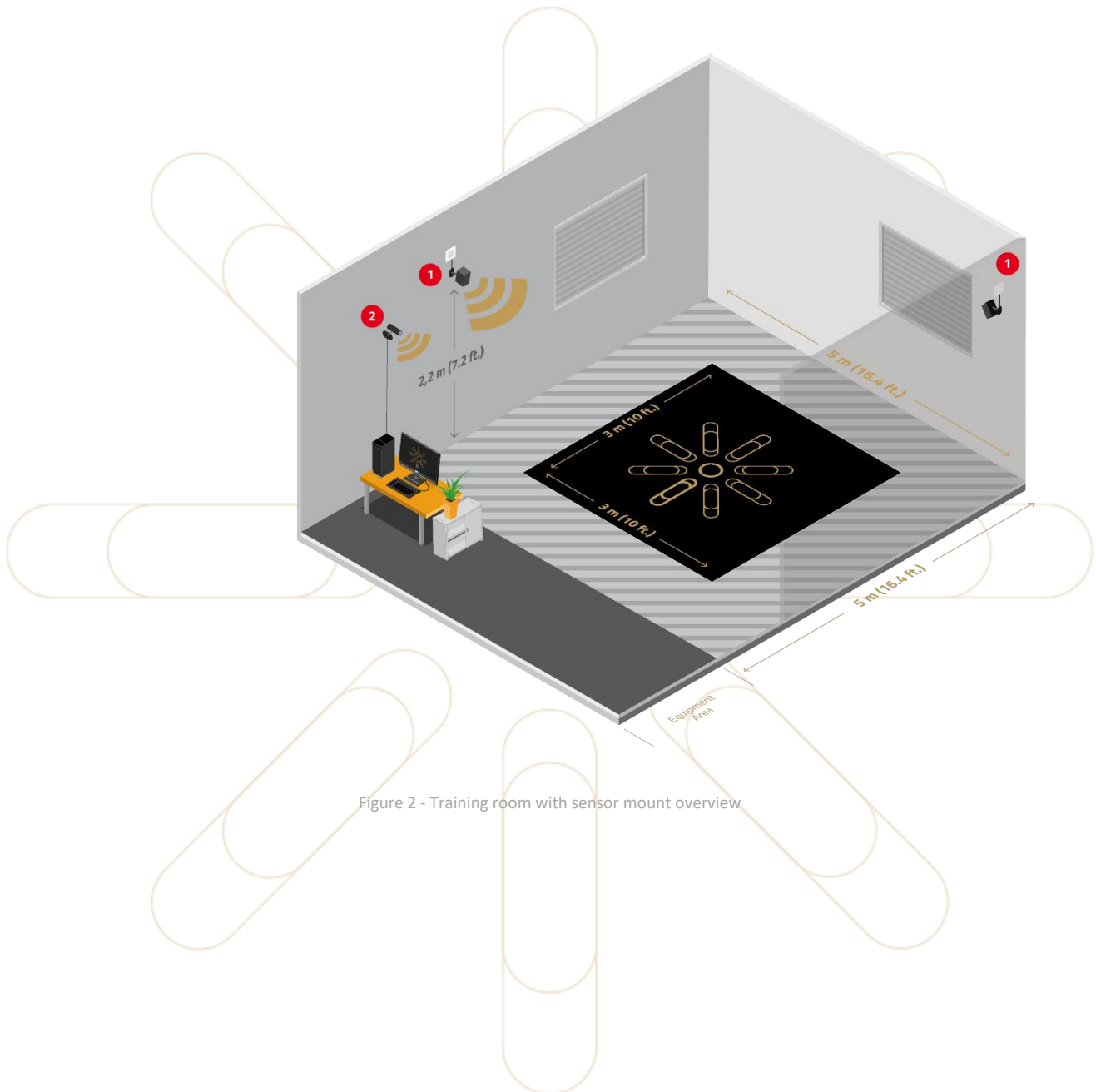

Figure 2 - Training room with sensor mount overview

Mounting the HTC VIVE Pro base stations (marked as 1 in the diagram above)

The HTC VIVE Pro base stations need to be mounted onto the **walls** or **ceiling** of the training room. The following illustration shows the position of the base station sensors.

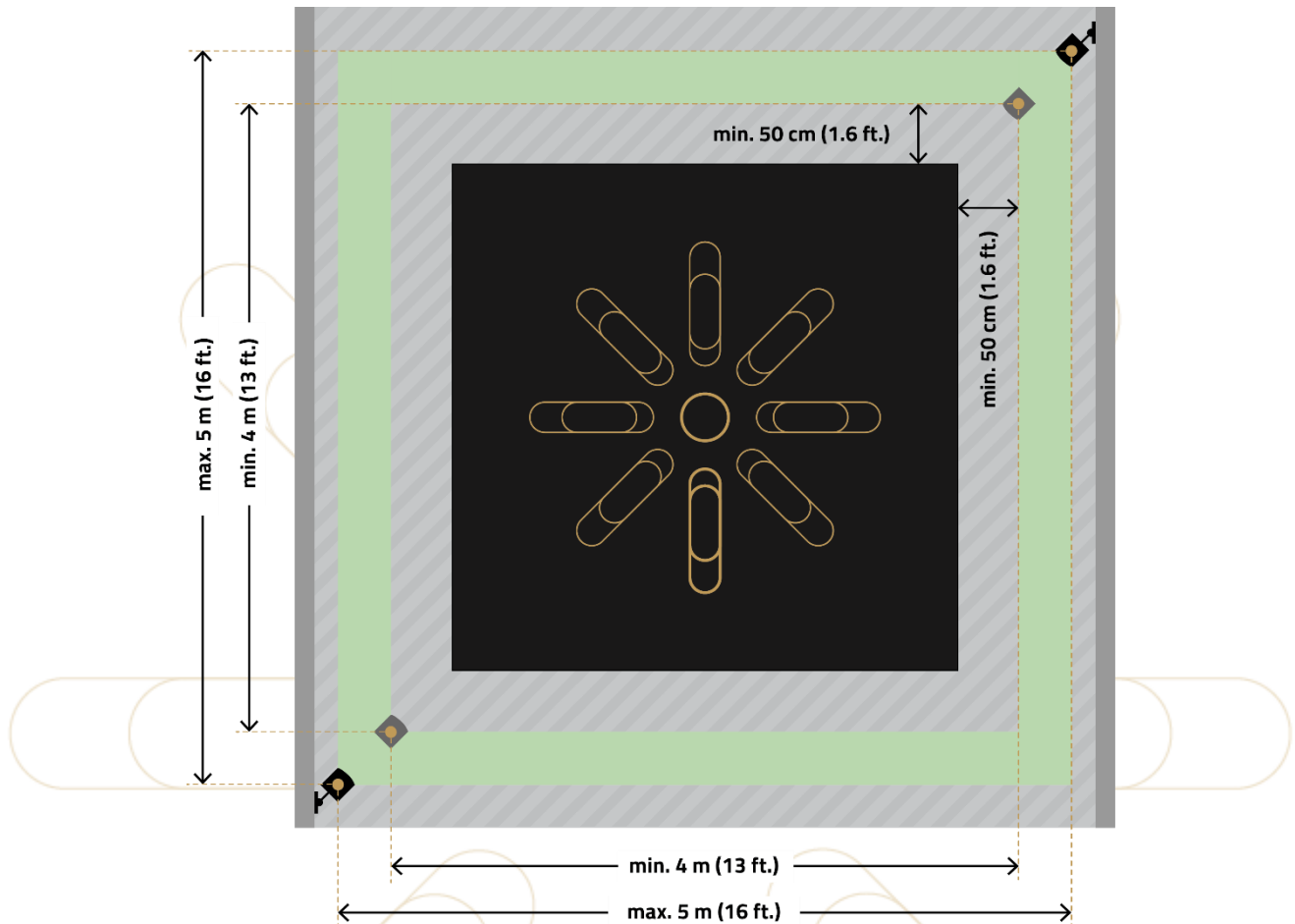

Figure 3 - Base station distance from a top-down view

The maximum distance between the two base stations is 7 m (23 ft.). This is what you get when the virtual reality play area has an outside dimension of 5 × 5 m (16 ft. x 16 ft.). Furthermore, the sensors must be placed at least 50 cm (1.6 ft.) outside of the training area.

The base stations must be mounted **at least 2.2 m (7.2 ft.) above the ground** to the center of the mount. The mount can be positioned vertically as well as horizontally.



Figure 4 - Base station distance above the ground

Two 6 mm (0.2 in.) holes for each of the base stations are required. The mounting kits include the screws, dowels, and the mount for the base stations and can be found in **Box 2** of the HTC VIVE Pro set.

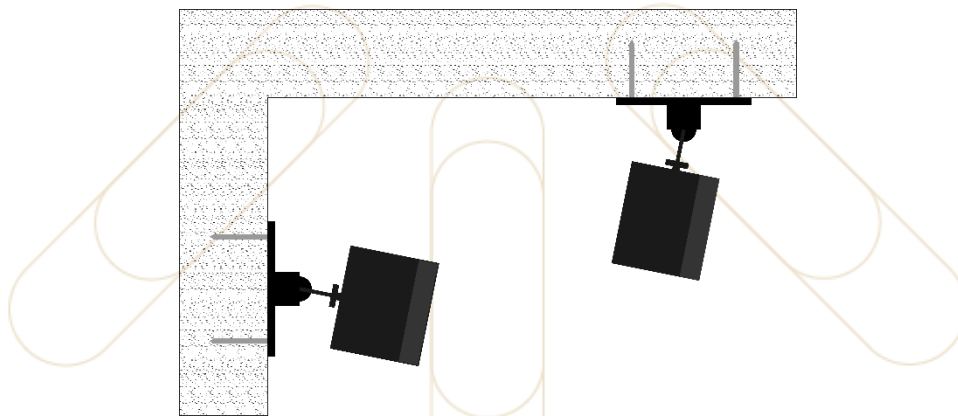

Figure 5 - Mount the sensors either on the ceiling or on the wall.



Notice

The mounting kit includes dowels for concrete material. The fixing material must be selected so that it matches the substrate.

Mounting the HTC wireless link box (marked as 2 in the diagram above)

The wireless link box is connected via cable to the back of the workstation. Therefore, it is important that the position of the workstation is known so that the holes can be drilled in the correct place. The cable has a length of 2 m (6.5 ft.).

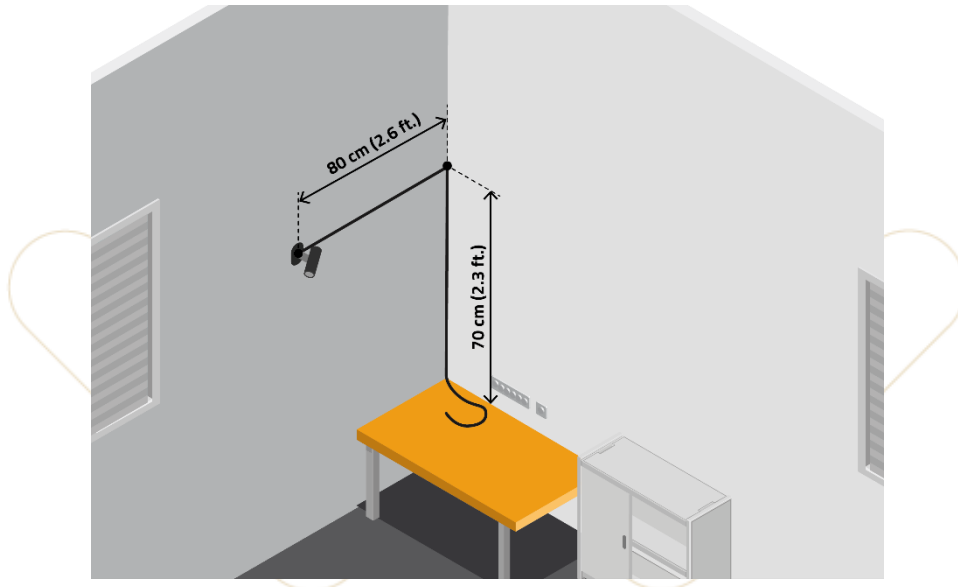

Figure 6 - HTC wireless link box mount option 1

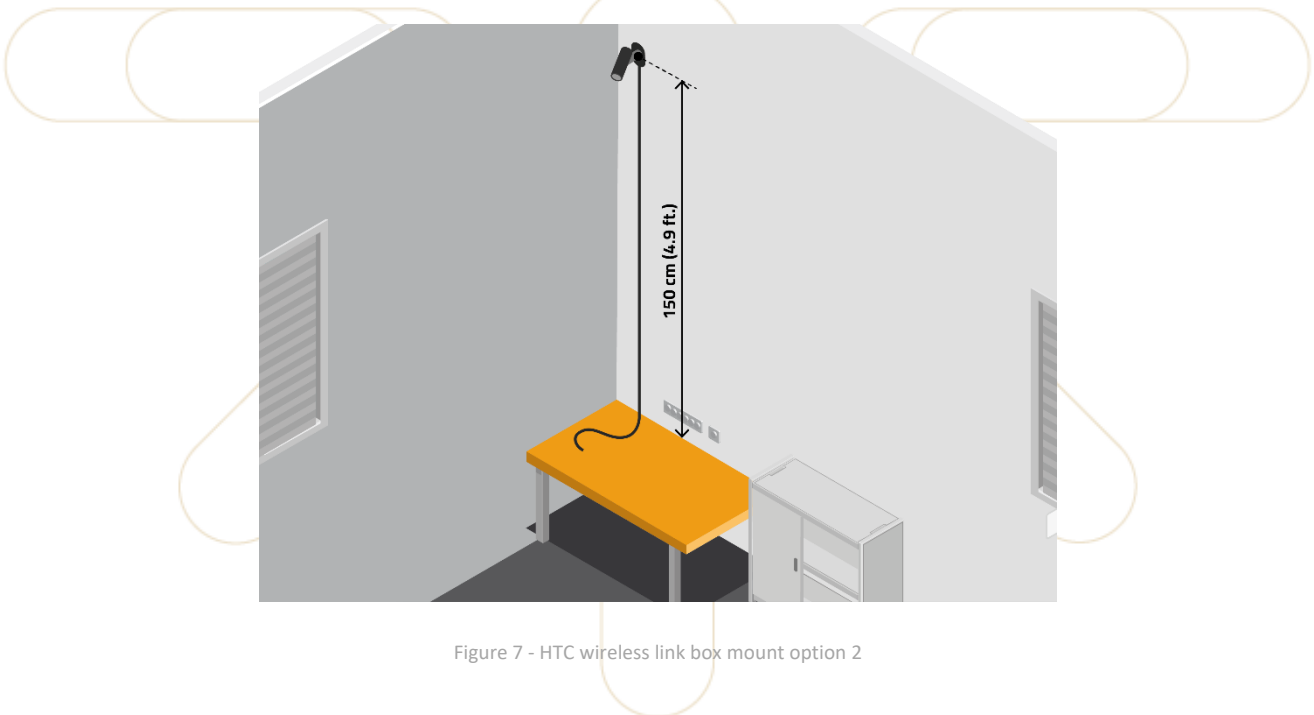

Figure 7 - HTC wireless link box mount option 2

Notice
 The sensor must have a **clear view** to the virtual reality play area.

Another two 6 mm (0.2 in.) holes are required to mount the wireless link box on the wall. The mounting kit can be found in the box of the HTC VIVE wireless adapter. It is recommended to position the mount horizontally.

6.3 Equipment Storage

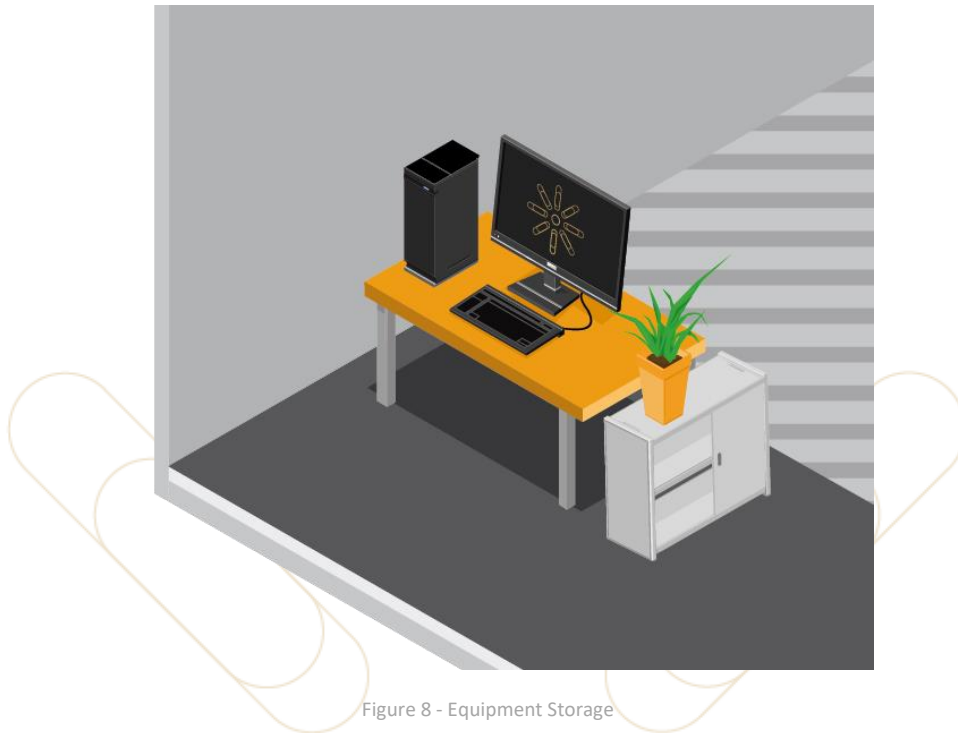

Figure 8 - Equipment Storage

We recommend that all components that are not fixed are stored in a lockable cabinet. Therefore, as referenced in the room requirements sheet, a storage locker that is at least **110 cm × 104 cm × 42 cm** or **43.3 in. x 40 in. x 16.5 in.** (W × H × D) should be made available for the training room.

6.4 Covering Reflective Surfaces

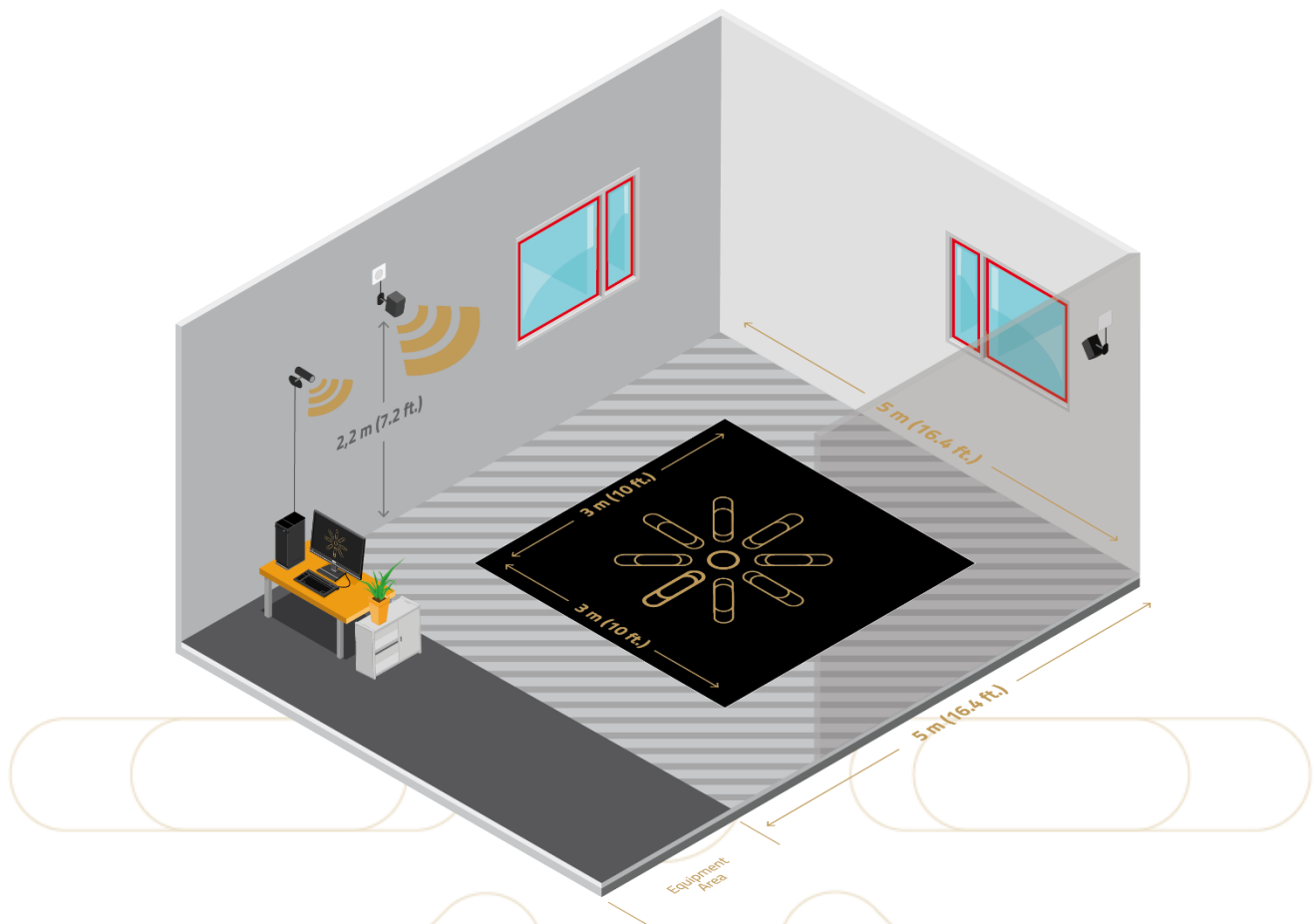

Figure 9 - Cover reflective surfaces

Reflective surfaces such as windows and mirrors almost certainly interfere with the virtual reality tracking system and negatively affect the training. It is therefore essential that all reflective surfaces are covered before any training is attempted. Internal blinds or curtains should be used to cover the windows from the inside.

Notice
 External blinds are not sufficient as they do not prevent the inside of the windows from reflecting into the room.

Disclaimer
 Please note, that motion sensors or other high frequency emitting devices might interfere with the VR setup.

6.5 Checklist

Step	Task	Task Complete?
Setting up the Equipment Area	Desk/Table supplied and placed in an appropriate position in the room.	
Drilling Holes to Mount Equipment	6 holes drilled and mounting kits attached to the walls in the correct position.	
Equipment Storage	Storage available and placed in an appropriate position.	
Covering Reflective Surfaces	All reflective surfaces covered.	

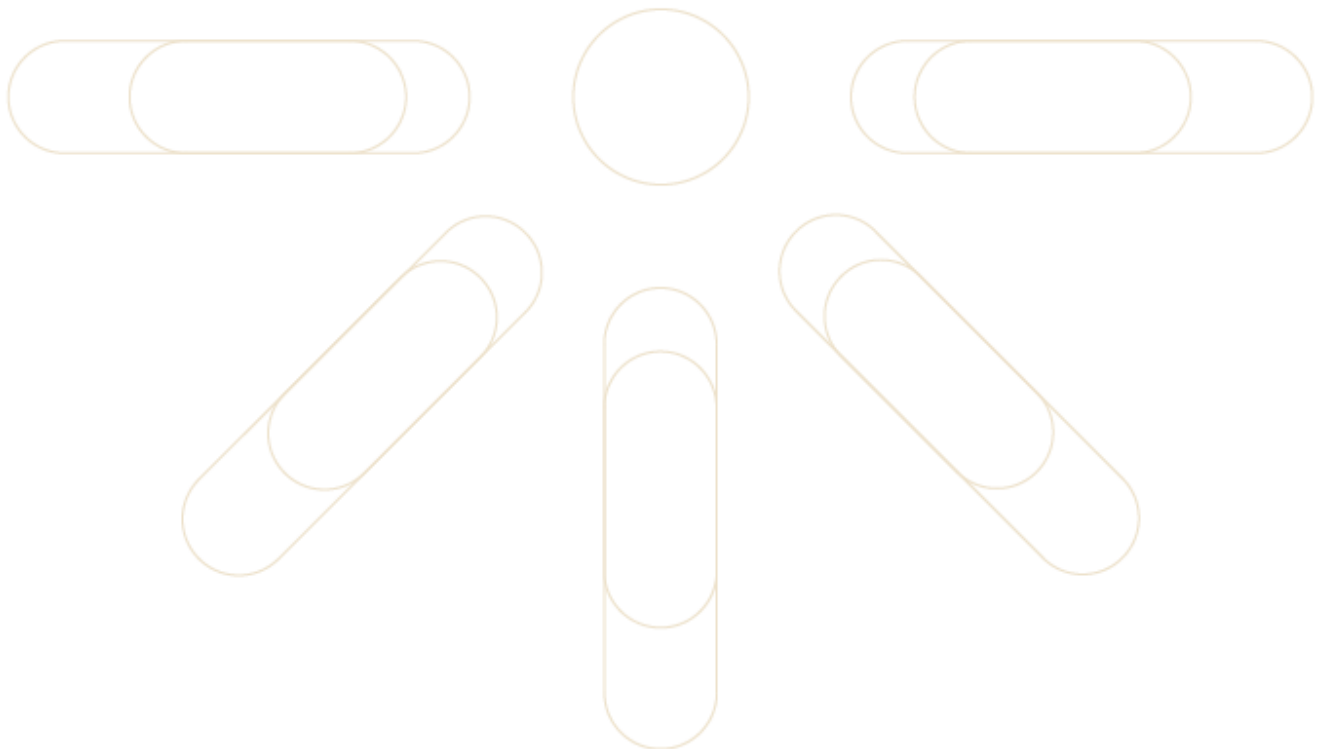

7 Installing the Primary Equipment

1. Open the box containing the workstation and remove all the equipment parts.
2. Open the box containing the monitor and remove all the equipment parts.
3. Using the instructions found in the box, connect the monitor to the base.
4. Place the monitor on the desk.
5. Connect the monitor and the workstation with the provided cable. Use the connectors in the green outlined section (see Figure 10 - Connect the monitor with the workstation).

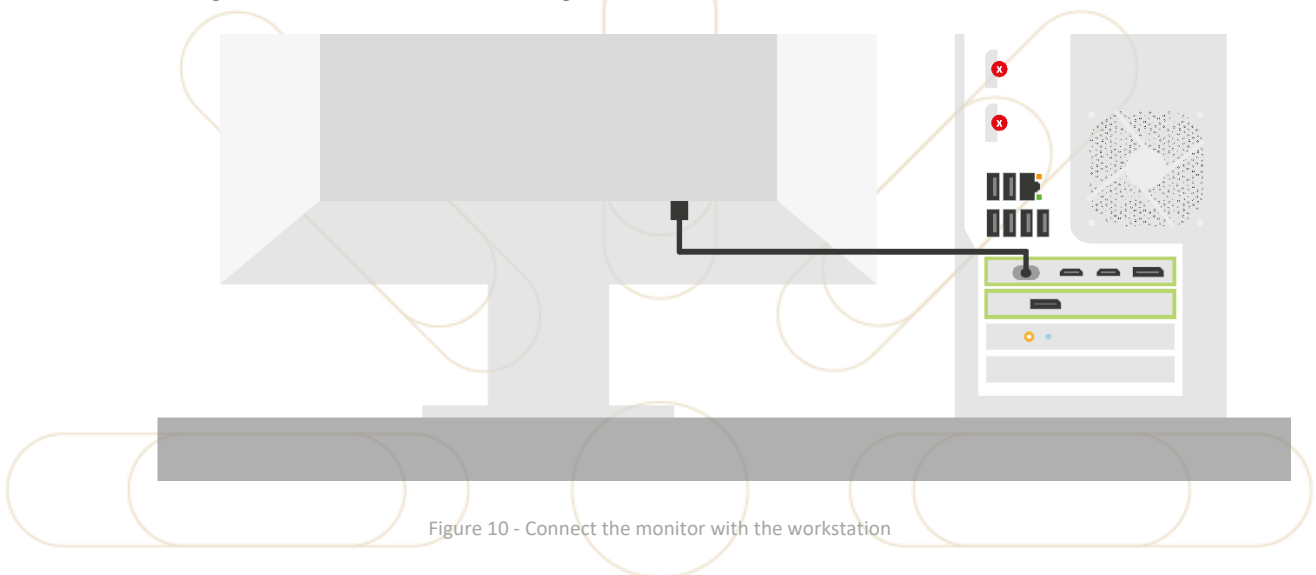

6. Network
 - a) **Ethernet:** Connect an Ethernet cable to the Ethernet port on the back of the workstation.
 - b) **Wi-Fi:** The workstation has also a Wi-Fi dongle already attached to the device. The preferred option for the connection is via Ethernet to avoid connection problems.

7. Remove the wireless link box from the HTC VIVE wireless adapter box and attach it to the horizontally positioned wall mount. After attaching the adapter, adjust it to be targeted to the center of the training area.



Figure 11 - Mount the sensor on the holder

8. Mount the other end of the wireless link box cable to the rear side of the workstation.

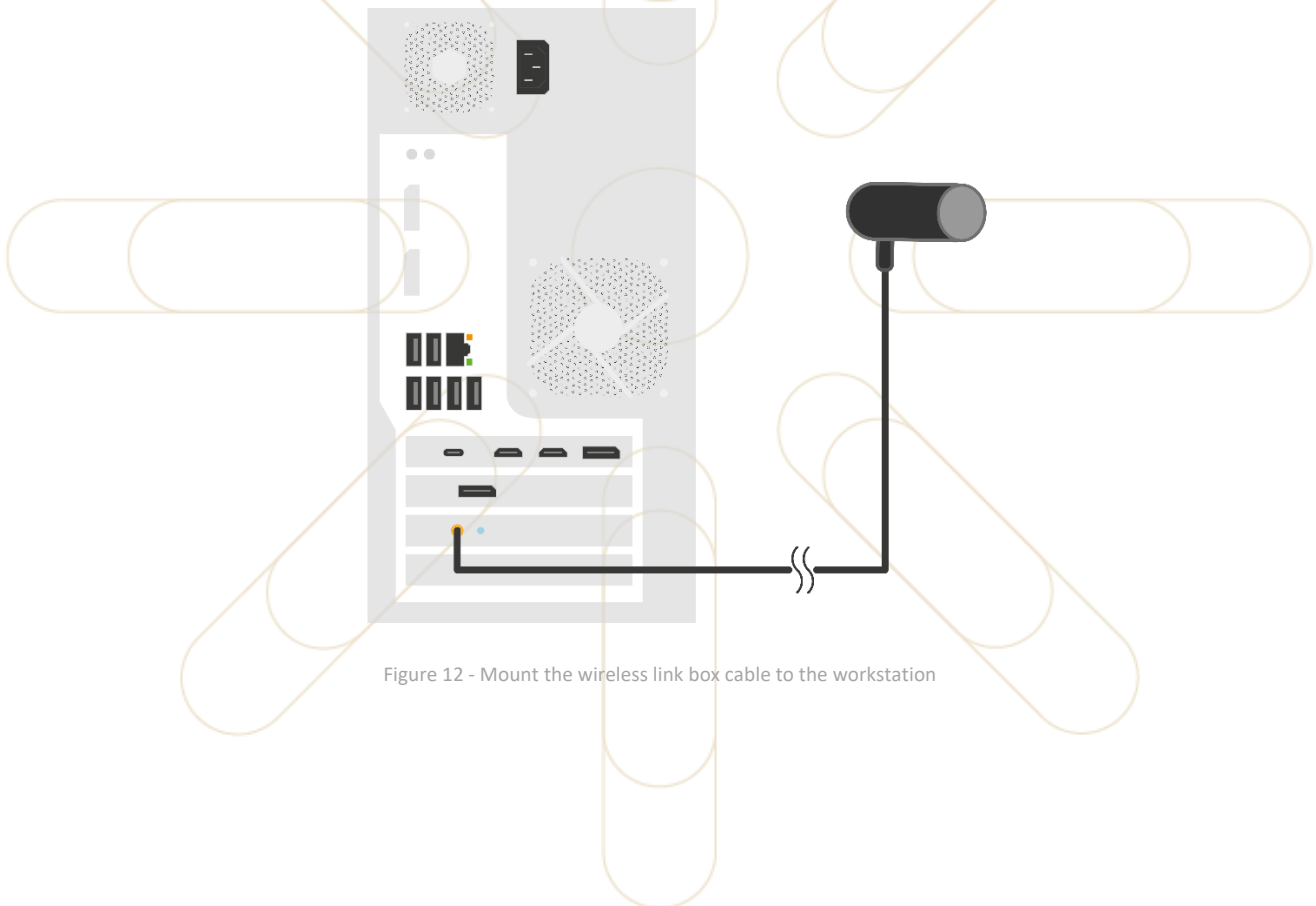

Figure 12 - Mount the wireless link box cable to the workstation

9. Remove the link box from **Box 3** of the HTC VIVE Pro set.
10. Stick the link box to the top of the workstation.

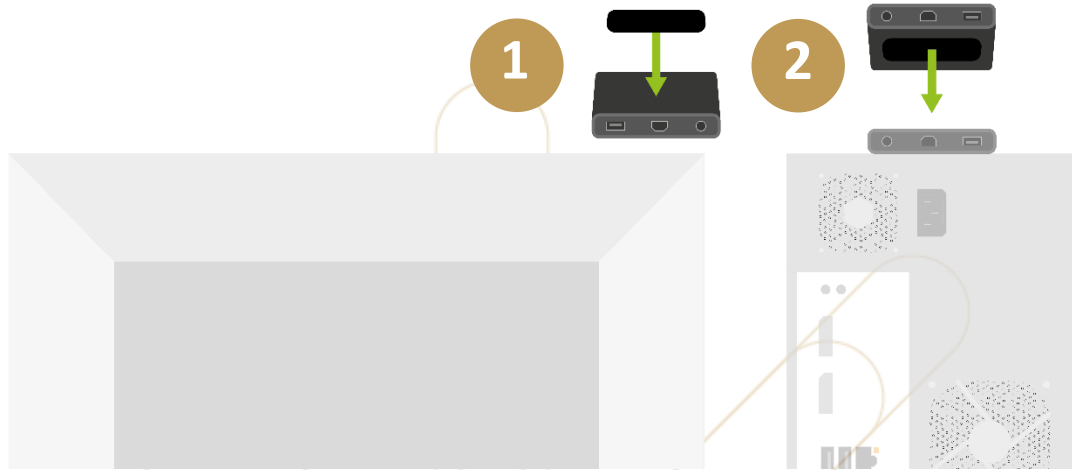

Figure 13 - Mount link box on workstation

- a) Use the mounting pad from **Box 3** of the HTC VIVE Pro set and stick it on the link box.
- b) Stick the link box on the workstation.

11. Connect the cables from the link box to the workstation.

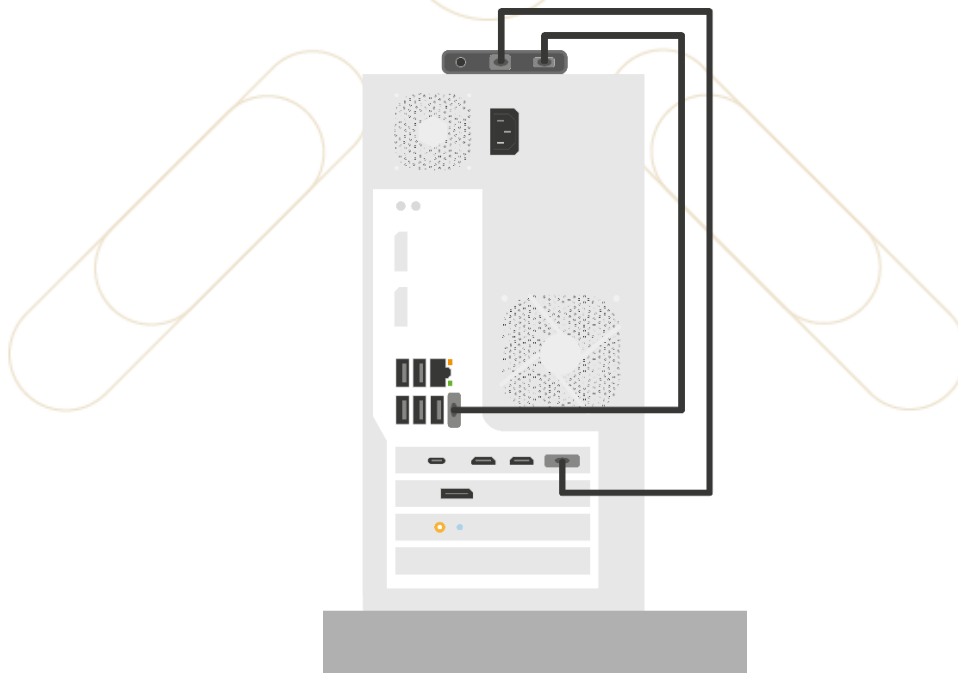

Figure 14 - Connect link box to workstation

- a) Connect the USB 3.0 cable and the DisplayPort cable to the rear side of the link box.
 - b) Connect the other end of the USB 3.0 to the rear side of the workstation.
 - c) Connect the other end of the DisplayPort cable to the rear side of the workstation.
12. Open the box containing the Logitech Keyboard and Mouse and remove all the equipment parts (the Bluetooth receiver is already attached to the workstation).
 13. Remove the keyboard and mouse from their packaging and switch them on.
 14. Connect the workstation, the monitor, and the link box with the power supply.

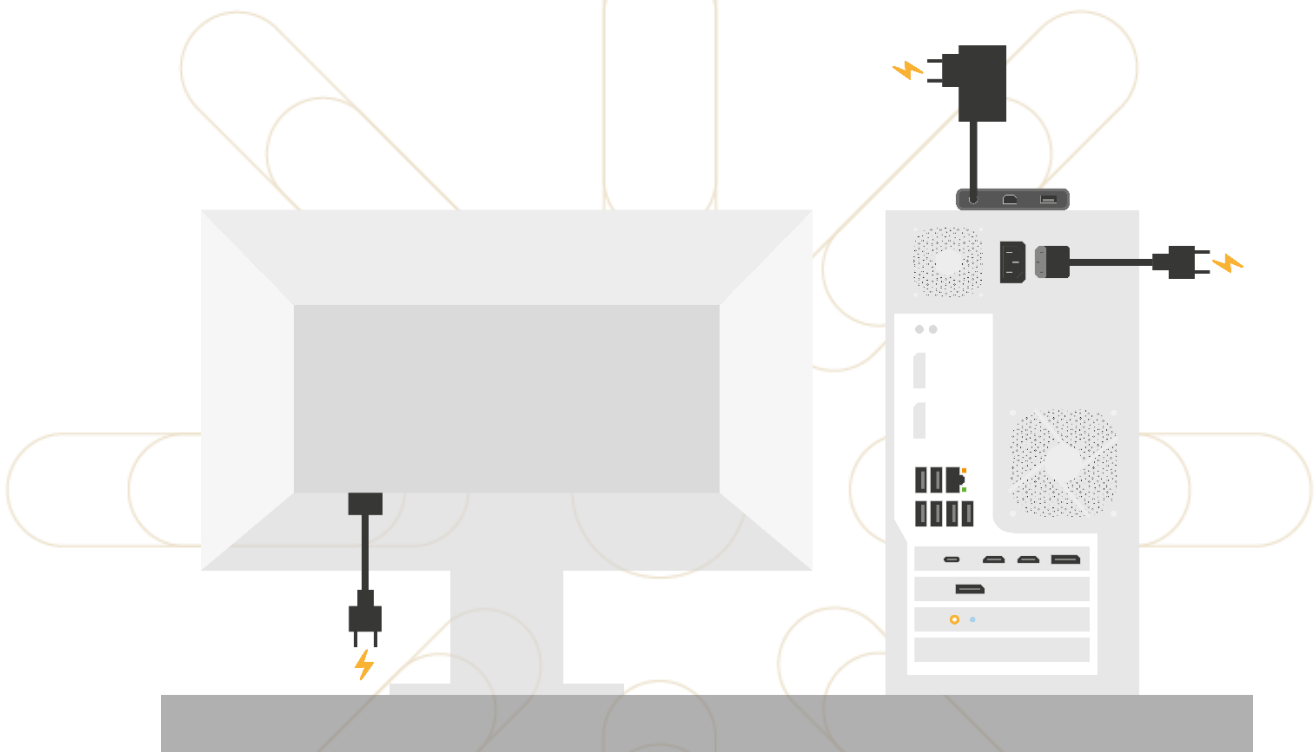

Figure 15 - Connect the monitor and the workstation with a power supply

- Remove the base station sensors and power adapters from **Box 2** of the HTC VIVE Pro set.



Figure 16 - Base station illustration

- Attach the base stations to the wall mounts that have been fitted. Adjust the base stations so that the front panels are **facing towards the center of the play area** at a recommended angle between $\alpha=25^\circ$ and $\alpha=35^\circ$.

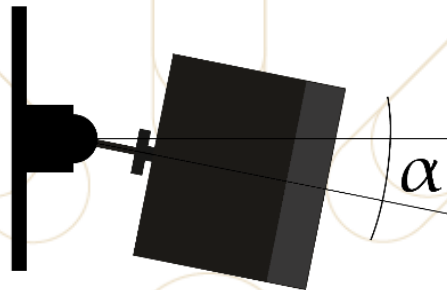

Figure 17 - Base station mount with angle

- Attach the power adapters to the rear side of each base station.

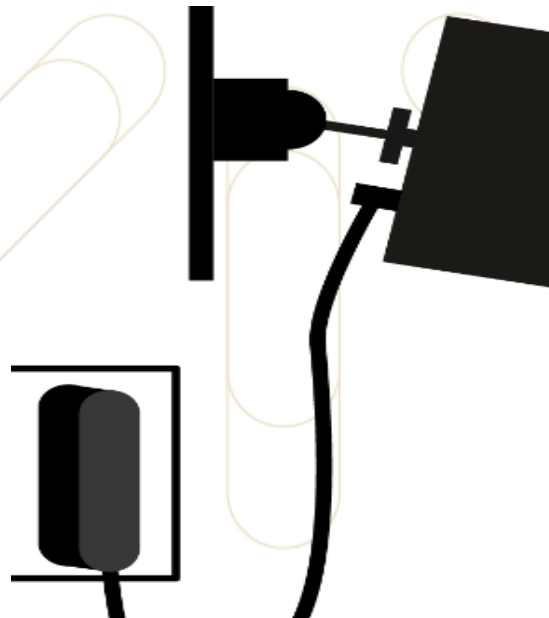

Figure 18 - Base station electrical connection

- Remove the headset from **Box 4** of the HTC VIVE Pro set and place it on the desk.

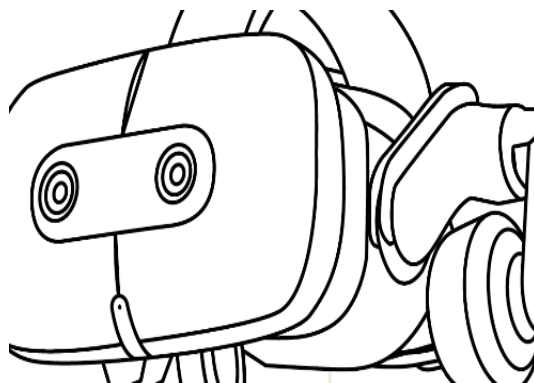

Figure 19 - Headset illustration

19. Remove the power bank, power bank holder, and power bank connection cable from the HTC VIVE wireless adapter set.

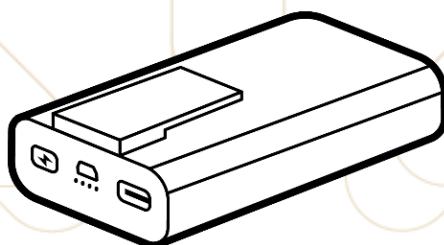

Figure 20 - Power bank illustration

20. Remove the two controllers from **Box 5** of the HTC VIVE Pro set and place them on the desk.

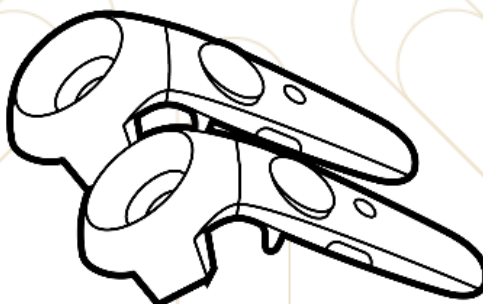

Figure 21 - Place controllers on desk

21. Two micro-USB cables can also be found in **Box 5**. Place them on the desk. They are needed to charge the controllers and to apply any future firmware updates.
22. Remove the USB charger from its packaging and connect it to the power supply.

23. Using their respective charging cables, connect the two controllers and power bank to the USB charger. **This will allow them to charge before they will be used later.**

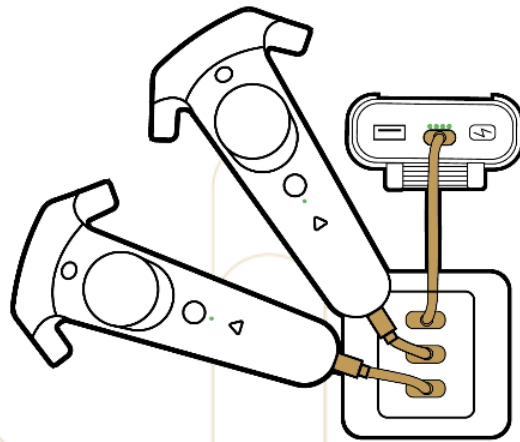
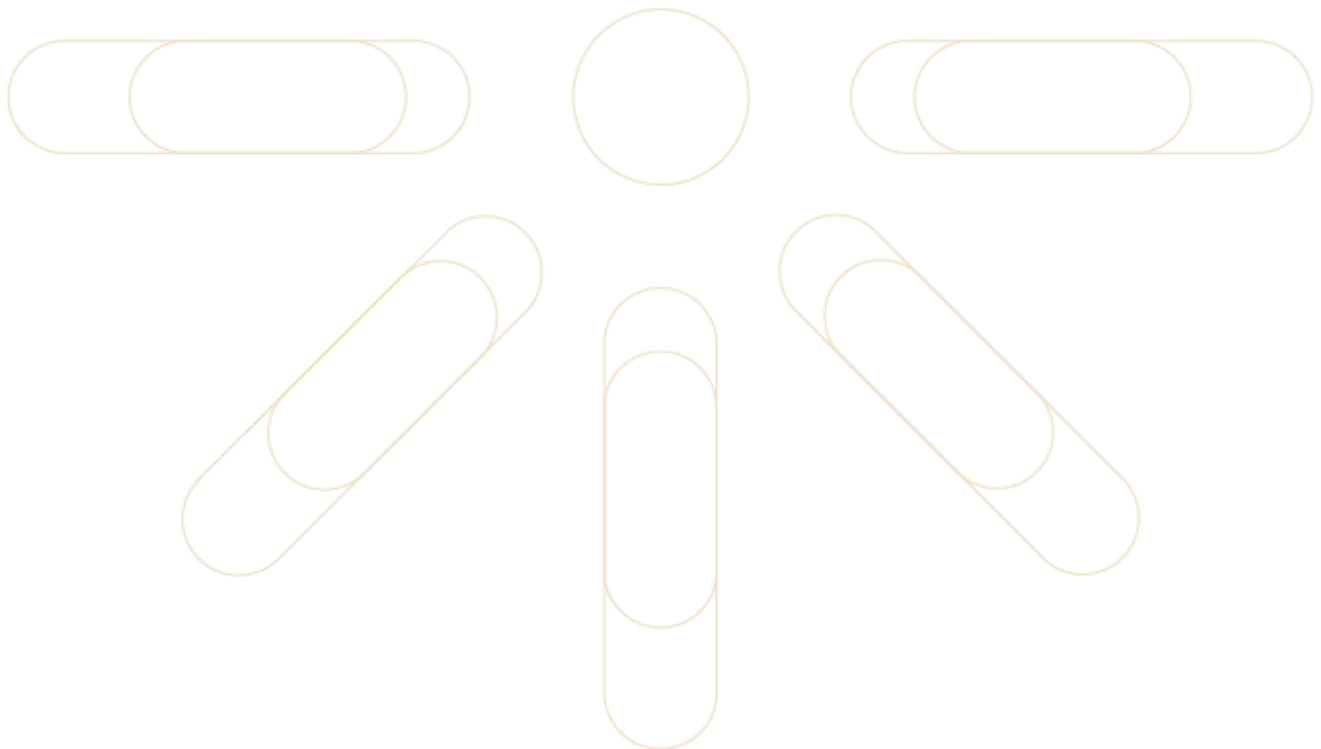

Figure 22 - Connect controllers and power bank with USB charger



7.1 Backup Equipment



Notice

If your order does not contain a backup workstation proceed onto the next section.

If two sets of equipment have been received, then the second set is to be treated as backup equipment which can be used in the event of any problems with the primary set of equipment.

The backup workstation should however be accessible remotely so that the Simulator software can be updated to match with the primary workstation. With that in mind, the following steps should be taken with the backup equipment.

1. Place the workstation upright on the desk next to the primary workstation.
2. Connect the power cable into the back of the workstation.
3. Connect the other end of the power cable to a power supply.
4. Connect a second Ethernet cable into this workstation.
5. Safely store all other hardware in the equipment storage locker as specified in the room preparation section above.

In the next section, the backup equipment will be tested using the monitor, keyboard, and mouse that has already been set up. **There is no need to set up these items from the second equipment set.**

7.2 Checklist

Step	Task	Task Complete?
Setting up the Workstation	Workstation built and placed under desk.	
	Workstation power supply connected and switched on at the back of the workstation.	
	Monitor connected to workstation and a power supply.	
	Keyboard and mouse switched on and Bluetooth receiver placed into a USB port on the workstation.	
	Ethernet cable connected to the workstation.	
Setting up the Virtual Reality Hardware	Wireless link box attached to wall mount and connected to workstation.	
	Base stations installed.	
	Link box installed.	
	Headset placed on desk.	
	Power bank placed into power bank holder.	
	USB charger connected to power supply and controllers and power bank connected and charging.	
Backup Equipment <i>(optional)</i>	Workstation built and placed under desk.	
	Workstation power supply connected and switched on at the back of the workstation.	
	All other backup hardware placed into storage.	

8 Starting the Equipment

Follow the steps below to correctly start all the equipment for the first time.

8.1 Starting the Workstation

The training workstation is configured using Windows Kiosk mode. This provides the user with access to a restricted windows desktop experience that only contains the applications that are required for the virtual reality training experience.

1. Switch on the workstation.
2. Switch on the monitor.

Once the correct display input has been selected and the workstation has loaded, you will be presented with the Windows Kiosk desktop.

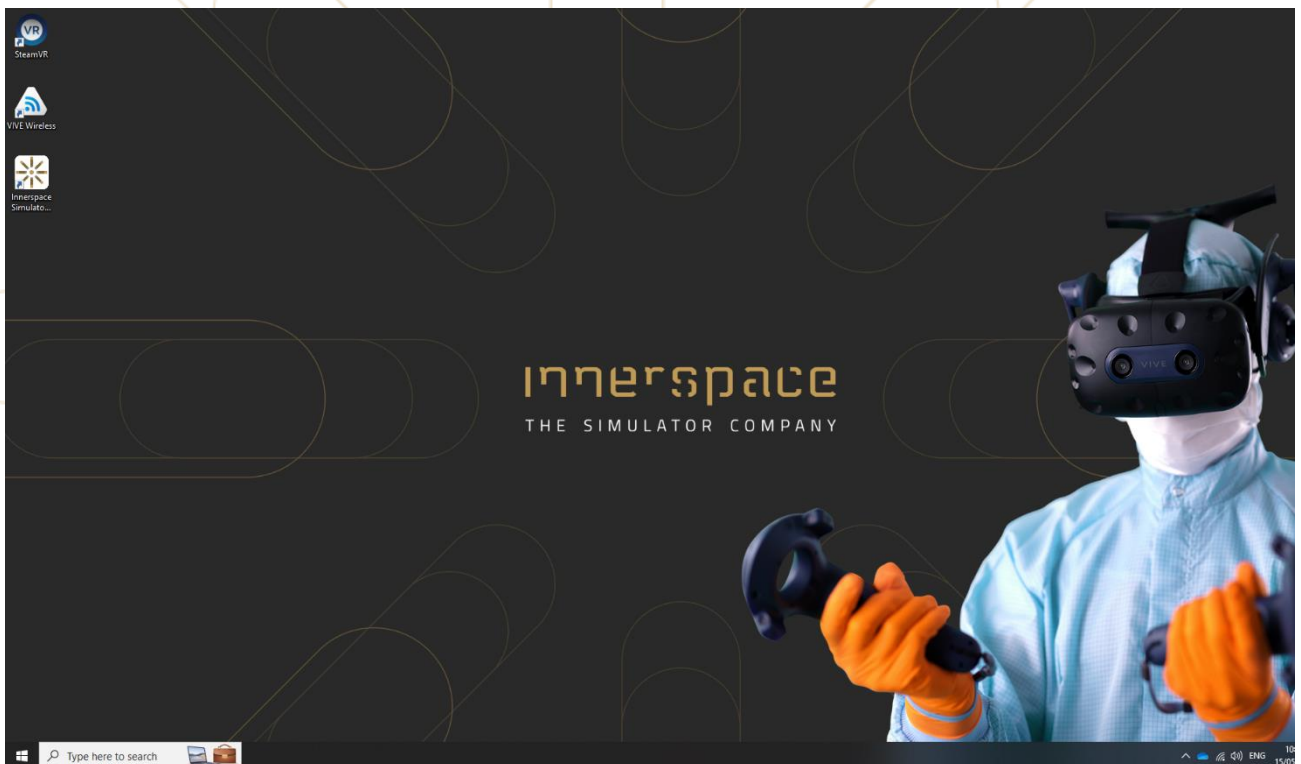

Figure 23 - Windows Desktop

3. Connect the workstation to a network.



Notice

Before starting any software, the next step is to start all the hardware.

8.2 Starting the Virtual Reality Hardware



Notice

Make sure the controllers and the power bank are at least half charged.

Follow these steps to start the hardware.

1. Connect both base station power adapters to a power connection. A blue light will appear on the base stations – only for a few seconds while they stabilize. After a few seconds, this light will turn green.

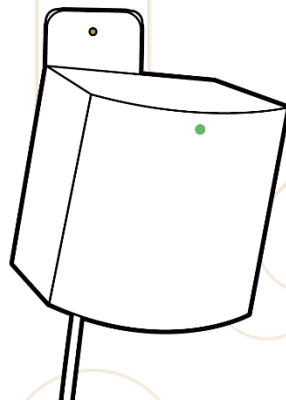

Figure 24 - Switch on base station sensors

2. Use the power bank connection cable to connect the power bank to the wireless adapter that is attached to the VIVE Pro headset. Switch on the power bank by pressing its power button. The green lights that appear next to this button indicate the battery level.

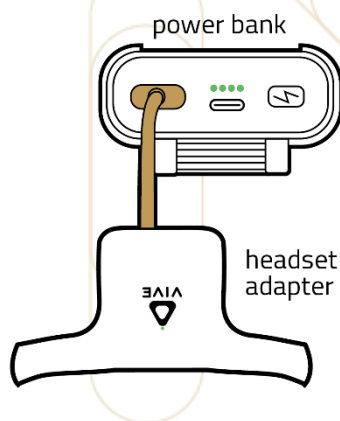

Figure 25 - Connect power bank with headset adapter

A green light will also appear on the headset adapter. This light will remain blinking until the headset is connected to the VIVE wireless application on the workstation, as detailed below.

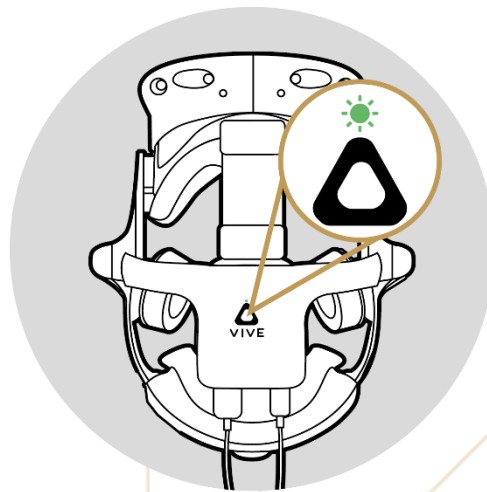

Figure 26 - Power indicator on the headset adapter

3. Place the headset and power bank on the floor in the middle of the training area. Use the Sharkoon XXXL gaming mouse mat to avoid placing the headset directly on the floor.

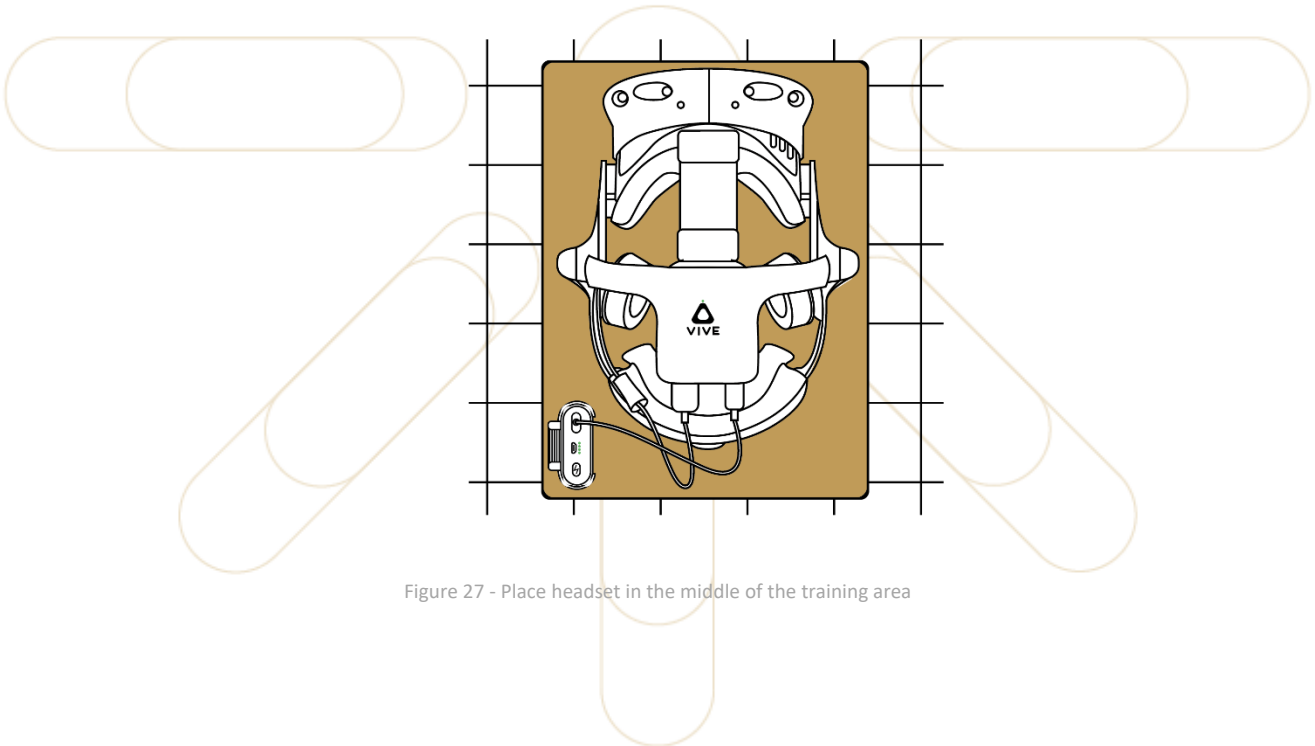

Figure 27 - Place headset in the middle of the training area

4. Switch on both controllers by holding down the power buttons – until you hear a beep.

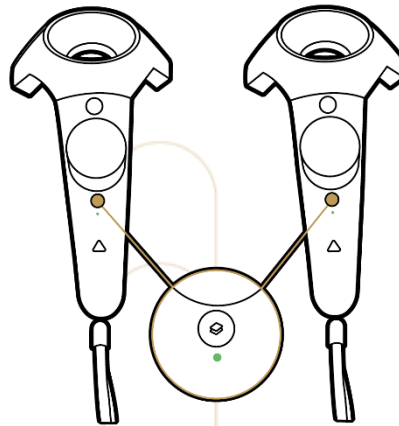

Figure 28 - Switch on both controllers

Once switched on, a solid blue light will appear on both controllers just below this button. Once this is done, place the controllers next to the headset in the middle of the training area.



Notice

The controllers will turn off if inactive for a short period of time. It may therefore be required to switch them back on at a later stage.

8.3 Configuring Hardware and Software

The next step is to connect the software on the workstation to the hardware.

1. On the workstation, start the VIVE Wireless application. This will attempt to connect to the wireless adapter that is on the headset. When connected, the blinking green light on the adapter will become solid and the application will display a status of **Ready**.

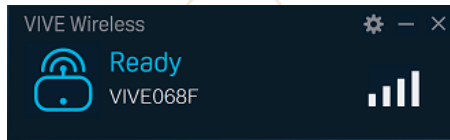

Figure 29 - Wait until VIVE Wireless is ready

If this status is not displayed, try re-pairing the headset. To do this, click the settings icon in the top right-hand corner and select **Pair new headset**.

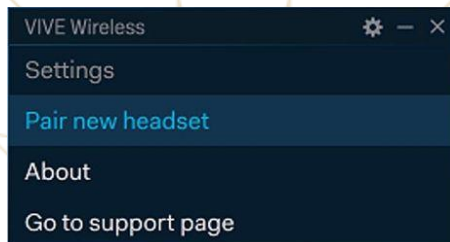

Figure 30 - Pair the headset if not connected

Follow the instructions on the screen to complete this process. Ensure that the headset can be clearly seen by the wireless link box that is mounted to the wall.

2. Start the SteamVR application. This will connect to the headset, the two controllers, and the two base stations. When connected, the application will show five icons with a solid color. The blue light on the controllers will also turn green once the connection is made.

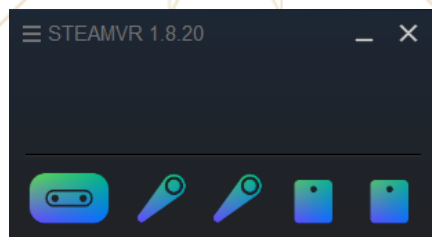

Figure 31 - Wait until SteamVR is ready

If the controllers do not connect check if they are still switched on. If they are switched on and not connecting, then the next step is to re-pair them. To do this, click the menu icon in the top left.-hand corner and select **Devices > Pair Controller**.

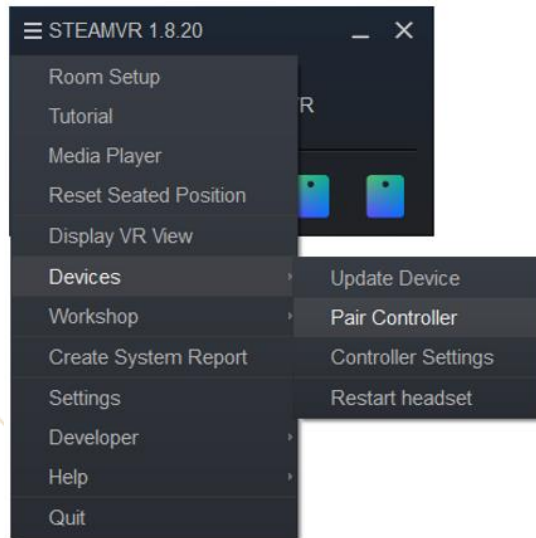

Figure 32 - Pair controllers

Follow the on-screen instructions to complete this process.

3. Click the menu icon in the top left.-hand corner and select **Room Setup**.

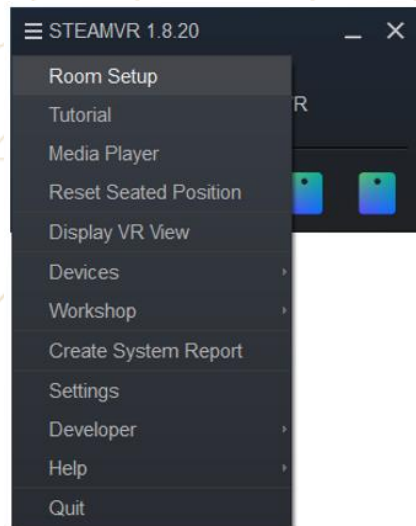

Figure 33 - Perform Room Setup

The following options will be displayed.
This is how the virtual reality play area boundaries are set. **ROOM-SCALE** setup is required.

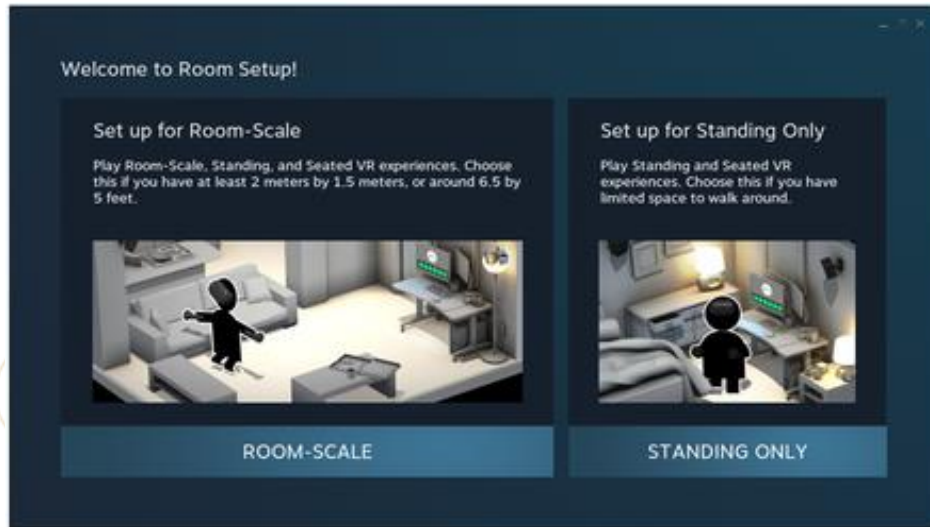
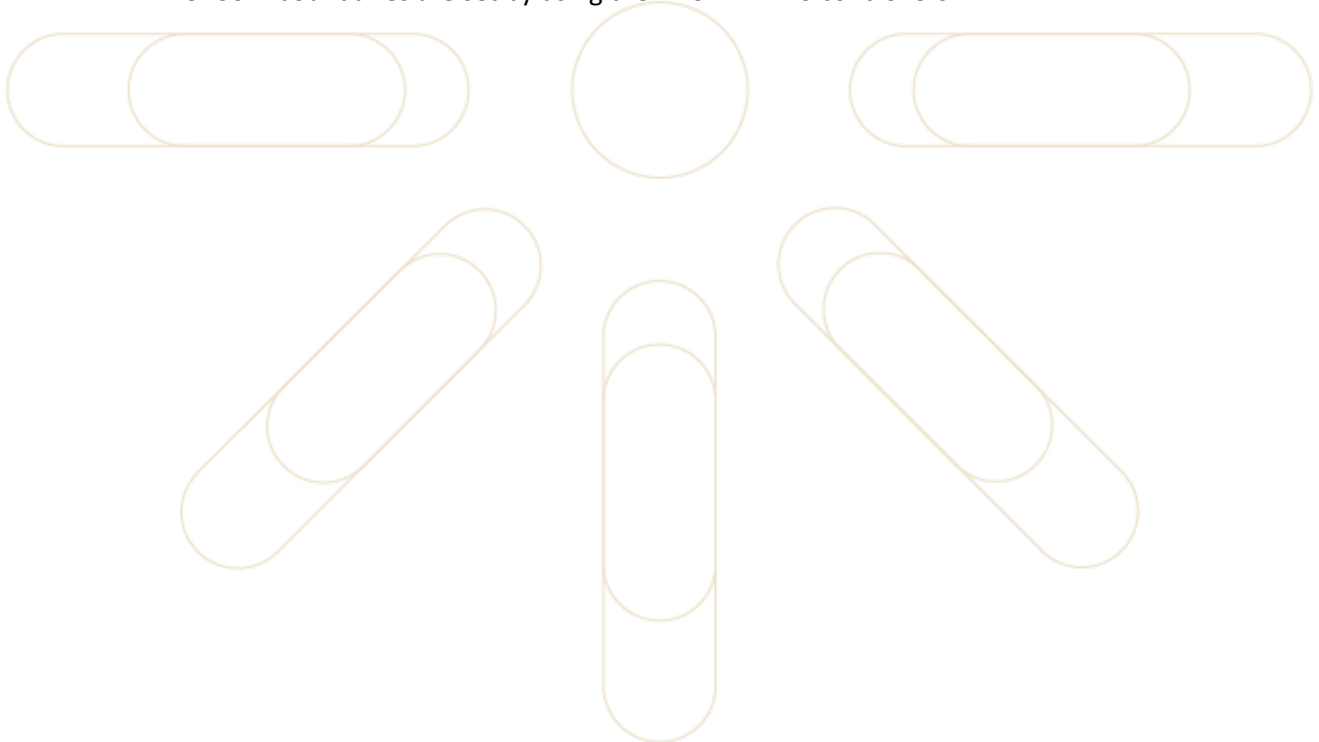

Figure 34 - Select Room-Scale

Select this option and follow the on-screen instructions to complete the process.

The room boundaries are set by using the HTC VIVE Pro controllers.



8.4 Backup Workstation



Notice

If your order does not contain a backup workstation you can skip this section.

The backup workstation needs to be switched on and tested to ensure that it has Internet access. Follow the steps below to do this.

1. Disconnect the monitor cable from the rear side of the primary workstation and connect it to the backup workstation.
2. Remove the keyboard and mouse USB Bluetooth receiver from the primary workstation and connect it to a USB port on the backup workstation.
3. Switch on the backup workstation.
4. After a few seconds, the Windows desktop should be displayed.
5. Open the Internet Explorer application and browse a website, for example <https://www.innerspace.eu>. If the page loads successfully then this confirms that you have internet access.

No further testing of the backup workstation is required. Once the test has been completed, the backup workstation should remain switched on and connected to the internet to allow for remote access by the Innerspace support team. The monitor, keyboard, and mouse should be reconnected back to the primary workstation.

1. Disconnect the monitor cable from the back of the backup workstation and re-connect it to the back of the primary workstation.
2. Remove the keyboard and mouse USB Bluetooth receiver from the backup workstation and re-connect it to a USB port on the primary workstation.

Once complete the Windows desktop from the primary workstation should be showing on the monitor display and the keyboard and mouse should be working.

The setting up of the equipment is now complete. For information on starting a training session visit the operational guides section of our online knowledge base.

8.5 Checklist

Step	Task	Task Completed
Starting the Workstation for the First Time	Workstation is switched on and the desktop is displayed on the monitor.	
Starting the Virtual Reality Hardware	Base stations are switched on.	
	Power bank is connected to the wireless adapter and switched on.	
	Controllers are switched on.	
Configuring Hardware and Software	Start the VIVE Wireless application and ensure it has a status of Ready .	
	Start the SteamVR application and ensure all components are connected.	
	SteamVR room setup complete.	
Backup Workstation	Connect the monitor, keyboard, and mouse to the backup workstation.	
	Turn the workstation on and test the internet access.	
	Re-connect the monitor, keyboard, and mouse to the primary workstation.	

9 Troubleshooting and FAQs

In the table below you will find recommended guidance for problems that may occur during the installation process and answers to some of the frequently asked questions.

Problem/Question	Recommended Action / Guidance
Equipment has arrived broken.	Contact Innerspace support via support@innerspace.eu to discuss further.
Equipment is missing from my order.	Contact Innerspace support via support@innerspace.eu to discuss further.
The VIVE Wireless application cannot connect to the headset.	<ol style="list-style-type: none"> 1. Ensure that the wireless adaptor is connected to the power bank and that the power bank is switched on. 2. If the power bank will not switch on, connect it to the USB charging cable. If green lights appear on the power bank, this will mean that it is charging. 3. Ensure that there is a clear view between the wireless link box and the headset. 4. Try re-pairing the headset by going to VIVE Wireless > Settings > Pair new headset and follow the on-screen instructions.
SteamVR does not detect the controllers.	<ol style="list-style-type: none"> 1. Make sure that the controllers are charged and switched on. 2. If they do not switch on, connect them to the USB charger for charging. An orange light on the controller indicates that it is charging. A green light indicates that it is fully charged. 3. If they still fail to connect after being successfully switched on, then re-pair them by going to SteamVR > Devices > Pair Controller and follow the on-screen instructions.
SteamVR does not detect the base stations.	<ol style="list-style-type: none"> 1. Ensure that the base stations are switched on. 2. Ensure that the base stations both have a clear line of sight to the headset.

<p>SteamVR prompts me to update the firmware on the headset, controllers, and base stations.</p>	<ol style="list-style-type: none"> 1. Follow the instructions given in SteamVR to complete this process. 2. If the update is for the base stations or controllers, you will be asked to connect these to your workstation using a micro-USB cable. If not already removed, a micro-USB cable can be found in Box 5 of the HTC VIVE Pro set. <p>The updates can sometimes take more than 30 minutes to complete. While firmware updates are in progress, do not unplug the micro-USB or power cables that connect your hardware to your workstation. This could result in a firmware error.</p>
<p>How do I charge the keyboard and mouse?</p>	<ol style="list-style-type: none"> 1. Both the keyboard and the mouse can be charged by using the USB charging cable that comes as part of the Logitech keyboard and mouse. 2. Connect one end of the cable to the keyboard or mouse and the other to either a USB port on the workstation or to the USB charger. The photos below show where you can find the USB connection on the mouse and on the keyboard.

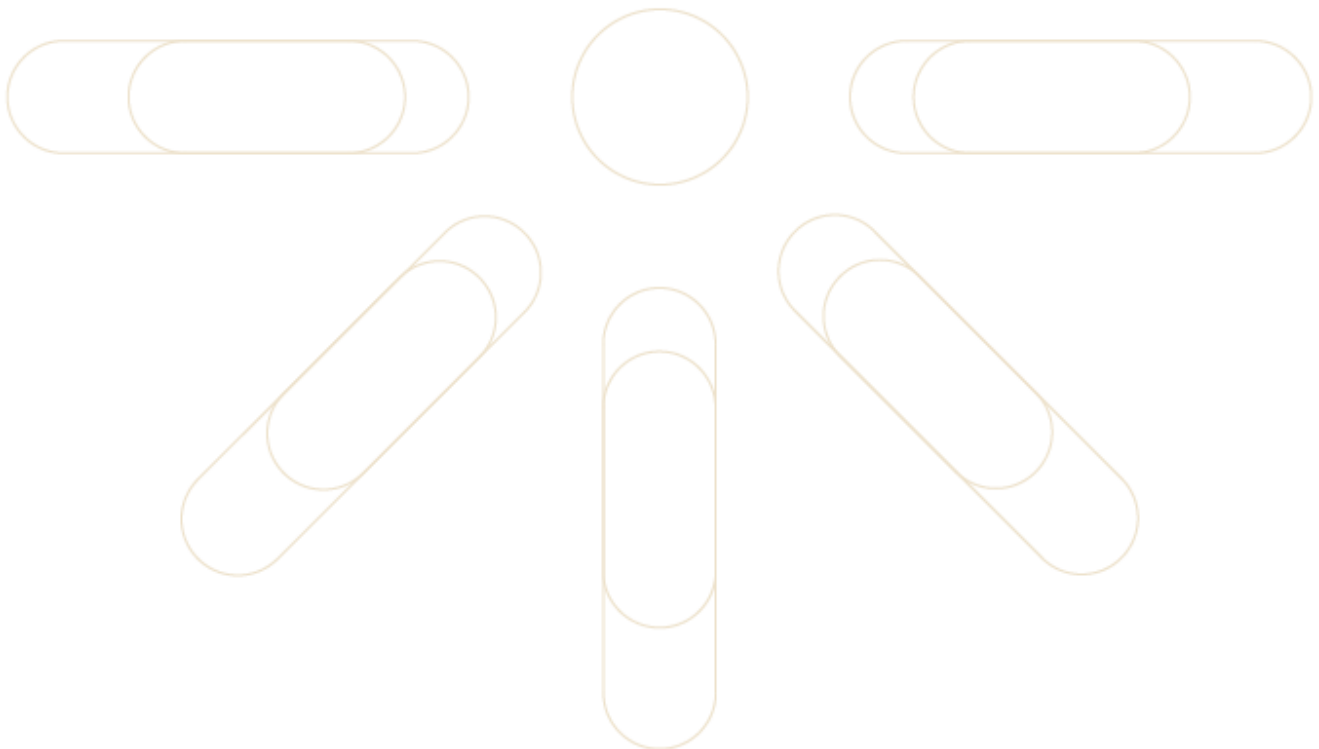

How do I reset my virtual reality play area?

1. In SteamVR, select the **Room Setup** option and follow the on-screen instructions.

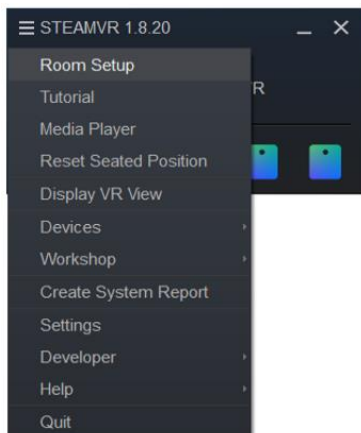

2. A **Room-Scale** play area is required.

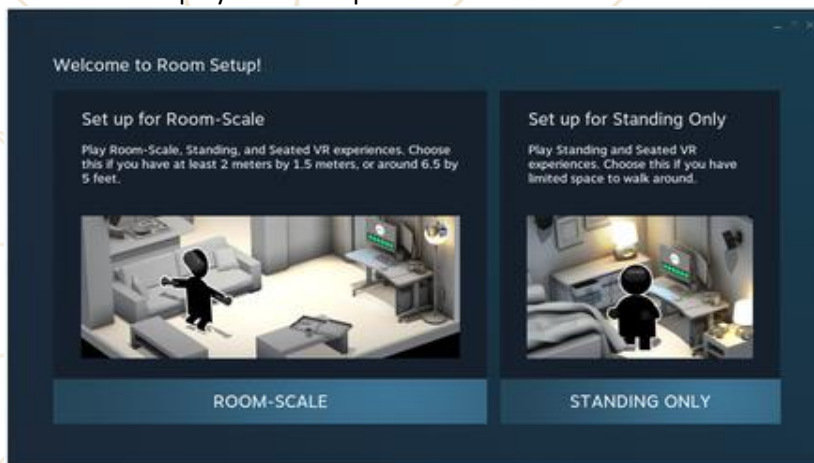

10 Appendix

10.1 Innerspace Support

If the recommended actions above, do not resolve your problems please contact Innerspace support to discuss further. The standard office hours are **9 am to 5 pm CET** on Austrian business days.

Phone	+43 (0)660 140 0971
Email	support@innerspace.eu
Knowledge Base	support.innerspace.eu
Address	Innerspace GmbH Helga-Krismer-Platz 1 6020 Innsbruck

10.2 References

- [1 H. Corporation, “VIVE Pro HMD User Guide,” 2018. [Online]. Available:
] [https://dl4.htc.com/Web_materials/Manual/Vive_Pro\(Enterprise\)/UserGuide/VIVE_Pro_User_Guide.pdf](https://dl4.htc.com/Web_materials/Manual/Vive_Pro(Enterprise)/UserGuide/VIVE_Pro_User_Guide.pdf).
- [2 H. Corporation, “VIVE Wireless Adapter (VIVE/VIVE Pro),” 2019. [Online]. Available:
] https://dl4.htc.com/Web_materials/Manual/Vive_Accessory/VIVE_Wireless_Adapter_User_guide_WWE.pdf.
- [3 Dell Precision 5820 Tower "Owner`s Manual", 2020 [Online]
] Available:https://dl.dell.com/topicspdf/precision-5820-workstation_owners-manual2_en-us.pdf
- [4 HP, “User Guide HP Z24n G2 Monitor,” 2017. [Online]. Available:
] <http://h10032.www1.hp.com/ctg/Manual/c05996984>.

10.3 Exclusion of Liability

ENGLISH

In case of damage, Innerspace is only liable for damage to the product itself. Any liability with regard to implicitly assumed characteristics and obligations, in particular with regard to the general usability and suitability for a certain purpose, is explicitly ruled out. The amount of any claim is restricted to the value of the product as paid by the customer. Any other claims, in particular compensation for lost profit, consequential damage, etc., are ruled out, except for cases of gross negligence. The burden of proof lies with the customer. Within the framework of product liability, Innerspace is only liable for personal injury suffered and material damage incurred by a consumer. Any modifications to the delivered object, non-compliance with the assembly instructions, particularly the safety instructions, non-observance of the product information, the use of non-original parts or parts not recommended by Innerspace, or the use for any non-intended purposes will release Innerspace from all liability. In the event of resale or transfer, the customer undertakes that he or she will pass on the liability restriction to subsequent customers. Subject to technical modifications. No liability for typographical errors.

GERMAN

Die Haft.ung von Innerspace bleibt auf Schäden beschränkt, die am Gegenstand des Produktes selbst entstehen. Die Haft.ung für implizit angenommene Eigenschaft.en und Pflichten, insbesondere hinsichtlich allgemeiner Gebrauchstauglichkeit und Eignung für einen bestimmten Zweck, wird ausdrücklich ausgeschlossen. Die Höhe des Schadenersatzes ist auf die Höhe des vom Käufer geschuldeten Warenwertes beschränkt. Jeder andere Schadenersatz, insbesondere Ersatz des entgangenen Gewinns, Folgeschäden etc., ist ausgeschlossen, sofern nicht grobes Verschulden vorliegt. Die Beweispflicht trifft. den Kunden. Im Rahmen der Produkthaft.ung haft.et Innerspace nur für Personenschäden und für solche Sachschäden, die ein Verbraucher erleidet. Änderung am Liefergegenstand, Nichteinhaltung der Montageanleitung und insbesondere der Sicherheitshinweise, Nichtbeachten der Produktinformation, die Verwendung nicht originaler oder von Innerspace empfohlener Teile, oder bestimmungsfremde Verwendung befreien Innerspace von der Haft.ung. Der Kunde verpflichtet sich, die Haft.ungsbeschränkung im Falle eines Weiterverkaufes oder einer Weitergabe auf spätere Kunden zu übertragen. Technische Änderungen vorbehalten. Keine Haft.ung für Druck- oder Satzfehler.

ITALIAN

La responsabilità di Innerspace rimane limitata ai danni che si verificano sull'oggetto del prodotto. La responsabilità per proprietà ed obblighi accettati implicitamente, soprattutto in relazione all'idoneità all'uso ed all'idoneità per uno scopo determinato in generale è esclusa esplicitamente. L'ammontare del risarcimento danni è limitato al valore dovuto dall'acquirente per la merce. Qualsiasi altro risarcimento danni, in particolare il risarcimento del guadagno mancato, di perdite consequenziali ecc., è escluso, se non vi è negligenza grave. L'onere della prova spetta al cliente. Nel quadro della responsabilità di prodotto Innerspace si assume la responsabilità solo per danni alle persone e per i danni alle cose, subiti dal consumatore. Modifiche all'oggetto della fornitura, la mancata osservanza delle istruzioni per l'installazione e soprattutto delle avvertenze per la sicurezza, la mancata osservanza delle informazioni di prodotto, l'uso di parti non originali oppure non raccomandate da Innerspace, oppure l'utilizzazione non conforme allo scopo esonerano Innerspace da qualsiasi responsabilità. Il cliente si impegna ad inoltrare la presente limitazione della responsabilità in caso di rivendita oppure di trasferimento del prodotto ai clienti successivi. Con riserva di modifiche tecniche. Si declina qualsiasi responsabilità per eventuali errori di stampa o di layout.

SPANISH

EN CASO DE DAÑOS, LA RESPONSABILIDAD DE INNERSPACE SE LIMITA A AQUELLOS QUE OCURRAN EN EL PRODUCTO PROPIAMENTE DICHO. Innerspace NO ACEPTA NINGUNA RESPONSABILIDAD POR LA CALIDAD DE LOS BIENES, EXCEPTO EN LA MEDIDA EN QUE ESTAS INSTRUCCIONES Y ADVERTENCIAS DISPONGAN DE OTRO MODO. INNERSPACE NO ASUME NINGUNA RESPONSABILIDAD EN EL SENTIDO DE QUE LOS BIENES SERÁN APTOS PARA EL PROPÓSITO PARTICULAR PARA EL CUAL EL CONSUMIDOR LOS HAYA COMPRADO, EXCEPTO EN LA MEDIDA EN QUE ESTAS INSTRUCCIONES Y ADVERTENCIAS DISPONGAN DE OTRO MODO. EL MONTO DE CUALQUIER RECLAMACIÓN SE LIMITA AL VALOR QUE EL CONSUMIDOR HAYA PAGADO POR EL PRODUCTO. SE RECHAZA CUALQUIER OTRO TIPO DE RECLAMACIÓN, COMO LA COMPENSACIÓN POR LUCRO CESANTE, LOS DAÑOS CONSECUENTES Y OTROS TIPOS DE DAÑOS, A EXCEPCIÓN DE CASOS DE NEGLIGENCIA GRAVE. LA CARGA DE LA PRUEBA QUEDARÁ A CARGO DEL CONSUMIDOR. CON RESPECTO A LA RESPONSABILIDAD RELATIVA AL PRODUCTO, INNERSPACE SOLAMENTE SERÁ RESPONSABLE POR LESIONES PERSONALES SUFRIDAS Y DAÑOS MATERIALES EN LOS QUE EL CONSUMIDOR HUBIERA INCURRIDO. CUALQUIER MODIFICACIÓN REALIZADA AL PRODUCTO ENTREGADO, FALTA DE CUMPLIMIENTO DE LAS INSTRUCCIONES DE ARMADO (INCLUIDAS LAS INSTRUCCIONES DE SEGURIDAD), NO OBSERVACIÓN DE ADVERTENCIAS DEL PRODUCTO, USO DE PIEZAS NO ORIGINALES O QUE NO HAYAN SIDO RECOMENDADAS POR Innerspace, Y USO DEL PRODUCTO CON FINES AJENOS A LOS PREVISTOS, EXIMIRÁ A Innerspace DE TODA RESPONSABILIDAD. EN CASO DE VENTA O TRANSFERENCIA, EL CONSUMIDOR ACEPTA LA OBLIGACIÓN DE TRASMITIR ESTA RESTRICCIÓN DE RESPONSABILIDAD A LOS CLIENTES ULTERIORES. ESTE PRODUCTO ESTÁ SUJETO A MODIFICACIONES TÉCNICAS. NO SE ASUME RESPONSABILIDAD POR ERRORES TIPOGRÁFICOS. ESTE DESCARGO DE RESPONSABILIDAD PUEDE NO SER EXIGIBLE EN TODOS LOS ESTADOS. EL VENDEDOR NO TIENE LA INTENCIÓN DE APLICAR O EJERCER TAL DESCARGO DONDE SEA LEGALMENTE INEXIGIBLE.

FRENCH

EN CAS DE DOMMAGE, INNERSAPCE NE POURRA ÊTRE TENU RESPONSABLE DES DOMMAGES AUTRES QUE CEUX QUI SONT SUBITS PAR LE PRODUIT LUI-MÊME. Innerspace N'ASSUME AUCUNE RESPONSABILITÉ POUR LA QUALITÉ DU PRODUIT SAUF POUR CE QUI EST INCLUS DANS CES INSTRUCTIONS ET AVERTISSEMENTS. Innerspace N'ASSUME AUCUNE RESPONSABILITÉ CONCERNANT LE BON FONCTIONNEMENT DU PRODUIT DANS LE BUT AVEC LEQUEL LE CONSOMMATEUR PEUT ACHETER CE PRODUIT SAUF POUR CE QUI EST INCLUS DANS CES INSTRUCTIONS ET AVERTISSEMENTS. LE MONTANT DE TOUTE RÉCLAMATION EST LIMITÉ À LA VALEUR DU PRODUIT TEL QUE PAYÉ PAR LE CONSOMMATEUR. LE CONSOMMATEUR RENONCE À TOUTES AUTRES RÉCLAMATIONS, PAR EXEMPLE LA COMPENSATION POUR PERTE DE PROFIT, DOMMAGES INDIRECTS ET AUTRES DOMMAGES SIMILAIRES SAUF EN CAS D'EXTRÊME NÉGLIGENCE. LA CHARGE DE LA PREUVE INCOMBE AU CONSOMMATEUR. POUR LA RESPONSABILITÉ DE PRODUIT, Innerspace N'EST RESPONSABLE QUE DES BLESSURES PERSONNELLES SUBIES ET DES DOMMAGES MATÉRIELS ENCOURUS PAR LE CONSOMMATEUR. TOUTES MODIFICATIONS DU PRODUIT LIVRÉ, NON-RESPECT DES INSTRUCTIONS DE MONTAGE (INCLUANT LES INSTRUCTIONS POUR LA SÉCURITÉ), NON-RESPECT DES AVERTISSEMENTS, L'UTILISATION DE PIÈCES QUI NE SONT PAS D'ORIGINE OU QUI NE SONT PAS RECOMMANDÉES PAR INNERSPACE OU L'UTILISATION DU PRODUIT À DES FINES NON PRÉVUES LIBÉRERA INNERSPACE DE TOUTE RESPONSABILITÉ. LORS D'UNE REVENTE OU D'UN TRANSFERT, LE (LA) CONSOMMATEUR (TRICE) S'ENGAGE À RECONDUIRE LA LIMITATION DE RESPONSABILITÉ AUX CONSOMMATEURS SUBSÉQUENTS. SUJET À DES MODIFICATIONS TECHNIQUES. AUCUNE RESPONSABILITÉ POUR DES FAUTES TYPOGRAPHIQUES. CETTE RENONCIATION DE RESPONSABILITÉ N'EST PEUT-ÊTRE PAS APPLICABLE DANS TOS LES ÉTATS. LE VENDEUR N'ENTEND PAS DEMANDER OU OBTENIR UNE TELLE RENONCIATION OÙ ELLE SERAIT LÉGALEMENT INAPPLICABLE.

DUTCH

Innerspace is alleen aansprakelijk voor schade aan het object zelf. De aansprakelijkheid voor impliciet aanvaarde eigenschappen en plichten, in het bijzonder met betrekking tot de algemene gebruiksgeschiktheid en geschiktheid voor een bepaald doel, is uitdrukkelijk uitgesloten. De hoogte van de schadevergoeding is beperkt tot het bedrag dat de koper voor de aankoop van het object is verschuldigd. Elke andere schadevergoeding, in het bijzonder de schadeloosstelling voor gederfde winsten, volgschaden etc. is uitgesloten, voor zover er geen sprake is van een grove schuld. De bewijslast ligt bij de klant. In het kader van de productaansprakelijkheid is Innerspace slechts voor persoonlijke schade en voor die productschaden aansprakelijk, die een consument heeft geleden. Veranderingen van het geleverde product, het niet opvolgen van de montagehandleiding en met name de veiligheidsinstructies, geen acht slaan op de productinformatie, de toepassing van niet-originele of door Innerspace aanbevolen onderdelen, of ongebruikelijke toepassingen ontheffen Innerspace van haar aansprakelijkheid. De klant verplicht zich, de aansprakelijkheidsbeperking in geval van het doorverkopen of doorgeven aan volgende klanten over te dragen. Technische wijzigingen voorbehouden. Geen aansprakelijkheid voor druk- of zetfouten.

DANISH

Innerspace's ansvar begrænses til skader, som opstår af sig selv på produktet. Ansvar for egenskaber og pligter, der antages som implicitte, især med henblik på generel brugsdygtighed og egnethed til et bestemt formål, udelukkes udtrykkeligt. Erstatningens størrelse begrænses til det beløb, der svarer til den vareværdi, som køberen skylder for. Enhver anden erstatning, især erstatning for tabt fortjeneste, følgeskader, m.m., er udelukket, såfremt der ikke foreligger grove misligholdelser. Bevisbyrden pålægges kunden. I forbindelse med produktansvar hæfter Innerspace kun for personskader og for materielle skader, som påføres en forbruger. Ændringer ved den leverede genstand, manglende overholdelse af monteringsvejledningen og især sikkerhed sans visningerne, ignorering af produktinformationen, anvendelse af uoriginale dele, eller dele, der ikke er anbefalet af Innerspace, eller anden anvendelse, der ikke er angivet i bestemmelserne, frigør Innerspace fra ethvert ansvar. Kunden forpligter sig til at overdrage ansvarsbegrænsningen til andre kunder i tilfælde af videresalg eller overdragelse. Med forbehold for tekniske ændringer. Der hæft.es ikke for tryk- eller satsfejl.

FINNISH

Innerspacen vastuu rajoittuu vahinkoihin, jotka syntyvät itse tuotteeseen. Valmistaja ei vastaa epäsuorasti oletetuista ominaisuuksista ja velvollisuuksista, erityisesti koskien yleistä käytettävyyttä ja sopivuutta tiettyyn tarkoitukseen. Vahingonkorvauksen määrä rajoittuu ostajan maksaman tavaran arvoon. Kaikki muut vahingonkorvaukset, erityisesti menetetyistä ansioista, seurausvahingoista jne. ovat poissuljetut, paitsi jos niiden syynä on törkeä laiminlyönti. Todistusvelvollisuus kohdistuu asiakkaaseen. Tuotevastuun puitteissa Innerspace vastaa ainoastaan henkivahingoista ja itse kuluttajan kärsimistä aineellisista vahingoista. Innerspacen vastuu raukeaa, mikäli toimitettuun tavaraan on tehty muutoksia tai jos asennus- tai erityisesti turvaohjeita ei noudatettu, tuotetietoja ei otettu huomioon tai on käytetty muita kuin alkuperäisiä tai Innerspacen suosittelimia osia tai jos laitteita on käytetty tarkoituksen vastaisesti. Jälleenmyyjä tai edelleen luovuttamisen yhteydessä asiakas on velvollinen siirtämään vastuunrajoitukset myöhemmille käyttäjille. Oikeus teknisiin muutoksiin pidätetään. Paino- tai ladontavirheistä ei oteta vastuuta.

POLISH

Odpowiedzialność firmy Innerspace ogranicza się do szkód powstałych na samym przedmiocie – produkcie. Wyraźnie wyklucza się odpowiedzialność z tytułu spodziewanych właściwości i

obowiązków, szczególnie w zakresie ogólnej przydatności do użytku i przydatności do określonego celu. Wysokość odszkodowania z tytułu szkody ogranicza się do wartości towaru, zapłaconej przez klienta. Wyklucza się wszelkie inne odszkodowania, w szczególności odszkodowanie za utracony zysk, szkody następcze itp. o ile nie stwierdzono wyraźnego zawinienia. Obowiązek dowodowy spoczywa na kliencie. W ramach rękojmi za produkt firma Innerspace odpowiada wyłącznie za szkody osobowe i rzeczowe poniesione przez użytkownika. Zmiany dokonane na przedmiocie dostawy, postępowanie niezgodne z instrukcją montażu, przede wszystkim niezgodne ze wskazówkami bezpieczeństwa, nieprzestrzeganie informacji o produkcie, stosowanie nieoryginalnych części zamiennych albo części nie zalecanych przez firmę Innerspace lub użytkowanie niezgodne z przeznaczeniem, zwalniają firmę Innerspace z odpowiedzialności. Klient zobowiązuje się do przeniesienia ograniczenia odpowiedzialności na kolejnego klienta w przypadku odsprzedaży lub przekazania produktu. Zastrzega się możliwość zmian technicznych. Nie ponosimy odpowiedzialności za błędy powstałe w druku lub podczas składu.

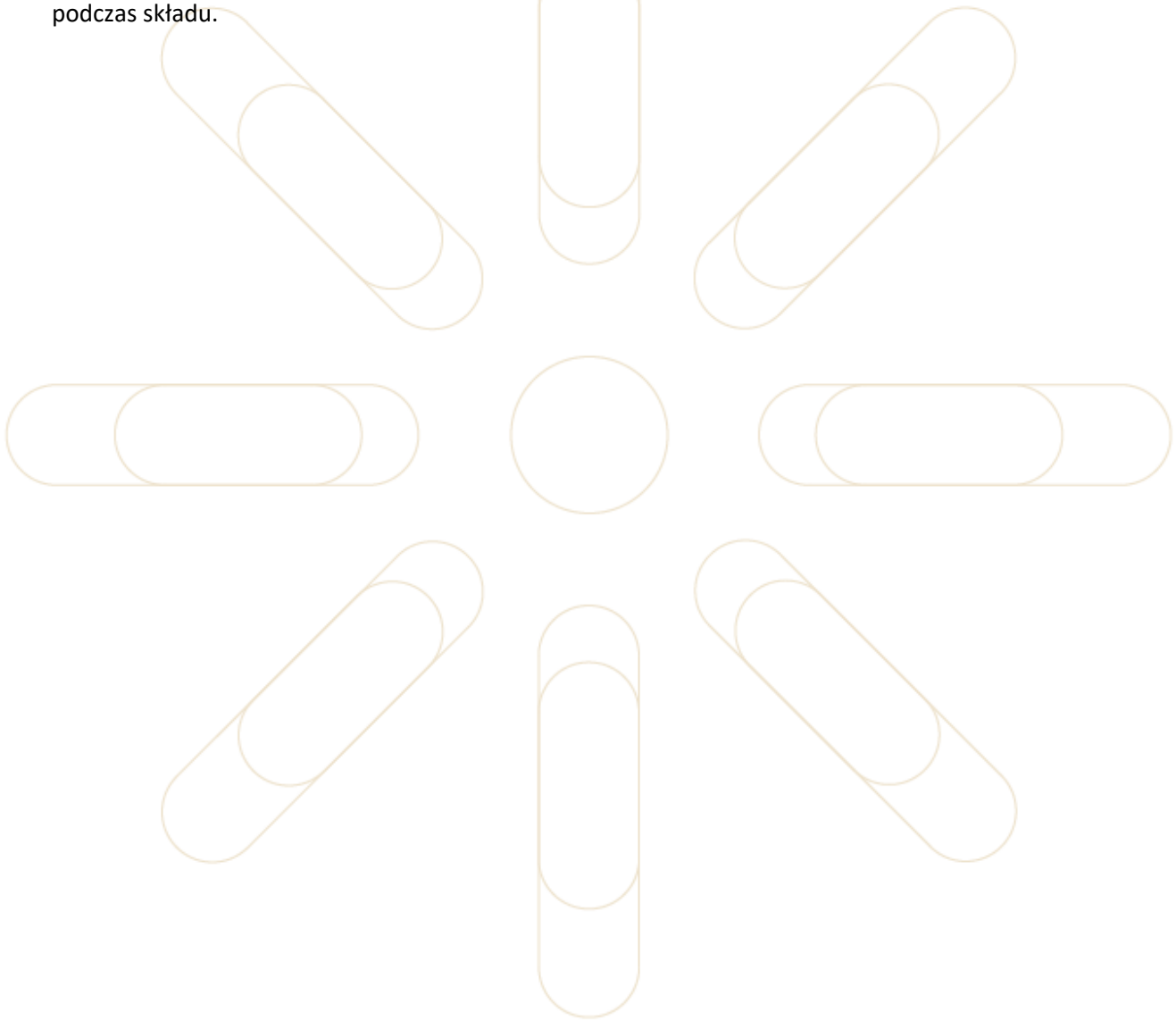

PORTUGUESE

A garantia da Innerspace limita-se a danos resultantes diretamente do produto. Fica expressamente excluída qualquer responsabilidade por funções e deveres implícitos, especialmente no que se refere à sua utilização generalizada ou adequação a fins específicos. O valor máximo para indemnização por danos fi ca limitado ao valor do produto danificado. Ficam excluídas quaisquer outras indemnizações, em especial indemnizações por perda de lucros, danos indiretos, etc., salvo em caso de negligência grosseira. O dever de prova recai sobre o cliente. No que se refere à responsabilidade pelo produto, a Innerspace só é responsável por danos pessoais e materiais referentes ao utilizador. Quaisquer alterações no produto original, o não cumprimento das instruções de montagem e, em especial, das instruções de segurança, a não observância das informações do produto, o uso de peças não originais ou recomendadas pela Innerspace, bem como uma utilização inadequada exoneram a Innerspace de qualquer responsabilidade. Em caso de venda ou cedência do produto a terceiros, o cliente fi ca obrigado a transmitir a presente garantia limitada. Reservado o direito a alterações técnicas. Não nos responsabilizamos por erros tipográficos ou de impressão.

CZECH

Ručení firmy Innerspace je omezeno na škody, které vzniknou na předmětu produktu samotném. Ručení za implicitně přijaté vlastnosti a povinnosti, zejména z hlediska obecné způsobilosti k použití a vhodnosti pro určitý účel, je výslovně vyloučena. Výše náhrady škody je omezena na výši hodnoty zboží dlužené kupujícím. Jakákoliv jiná náhrada škody, zejména náhrada ušlého zisku, následných škod atd., je vyloučena, pokud nedošlo k hrubému zavinění. Důkazní povinnost je na straně zákazníka. V rámci ručení za produkt ručí firma Innerspace pouze za škody na zdraví a za takové věcné škody, které utrpí spotřebitel. Změny předmětu dodávky, nedodržení návodu na montáž a zejména bezpečnostních pokynů, nedodržení informací o produktu, použití neoriginálních dílů nebo dílů nedoporučených firmou Innerspace, nebo použití, které není v souladu s účelem, zbavují firmu Innerspace ručení. Zákazník se zavazuje přenést omezení ručení v případě dalšího prodeje nebo předání na pozdější zákazníky. Technické změny vyhrazeny. Nepřebíráme ručení za chyby tisku nebo sazby.

SLOVAK

Záruka spoločnosti Innerspace sa obmedzuje na škody, ktoré vznikajú zo samotného predmetu produktu. Záruka na implicitne brané vlastnosti a povinnosti, zvlášť tých, ktoré sa týkajú všeobecnej použiteľnosti a spôsobilosti na určitý cieľ je výslovne vylúčená. Výška náhrady škody je obmedzená na výšku hodnoty tovaru, ku ktorej sa zaviazal kupujúci. Každá iná náhrada škody, zvlášť náhrada ušlého zisku, následné škody, je vylúčená, pretože nepodlieha hrubému zavineniu. Dôkazové bremeno spočíva na zákazníkovi. V rámci záruky na výrobky ručí spoločnosť Innerspace iba za osobné škody a také vecné škody, ktoré utrpel spotrebiteľ. Zmeny v predmete dodávky, nedodržanie návodu na montáž a zvlášť bezpečnostných predpisov, neriadenie sa podľa informácií o produkte, používanie neoriginálnych alebo spoločnosťou Innerspace neodporúčaných dielov, alebo použitie, ktoré nie je v súlade s účelom použitia, oslobodzujú spoločnosť Innerspace od záruky. Zákazník sa zaväzuje preniesť obmedzenia záruky v prípade ďalšieho predaja alebo prevodu na neskorších zákazníkov. Vyhradzuje si právo na zmeny. Neručíme za typografiu a chyby.

Hungarian/Magyar

A Innerspace kizárólag a terméken magán keletkező károkért vállal felelősséget. A Innerspace semmilyen felelősséget nem vállal a közvetett módon feltételezett termékutajdonságokért és a termékkel kapcsolatos elvárásokért, kiváltképpen a termék egy bizonyos célra való általános használhatóságára és alkalmasságára nézve. A kártérítés mértéke a vásárló által fi tézendő áruértékre

korlátozódik. Egyéb károk megtérítésére vonatkozó igény, ideértve különösen az elmaradt nyereséget, a következményi károkat stb. kizárólag súlyos vétkesség esetén támasztható. A bizonyítási kötelezettség a vásárlót terheli. A Innerspace a termékszavatosság keretén belül kizárólag személyi károkért és a fogyasztók anyagi káraiért tartozik felelősséggel. A szállított termék átalakítása, a szerelési útmutatóban foglaltak, különösen a biztonsági útmutatások be nem tartása, a termékinformációk fi gyalumén kívül hagyása, nem eredeti vagy a Innerspace által ajánlott alkatrészek felhasználása vagy a nem rendeltetés szerű használat esetén a Innerspace mentesül szavatossági kötelezettsége alól. A vásárló vállalja, hogy a termék tovább értékesítése vagy továbbadása esetén a szavatossági korlátozásokat is átruházza a mindenkori vevőkre. A műszaki változtatások joga fenntartva. Nyomdai vagy szedési hibákért nem vállalunk felelősséget.

RUSSIAN

Ответственность Innerspace ограничивается ущербом, нанесенным продукту. Ответственность за мнимые свойства и обязательства, в особенности касающиеся общей пригодности к использованию и пригодности для определенной цели, категорически исключена. Размер возмещения ущерба ограничивается размером выплаченной покупателем стоимости товара. Любое другое возмещение ущерба, властности, возмещение упущенной прибыли, косвенного ущерба и т.д. исключено, если не имеет место грубая вина. Бремя доказывания лежит на покупателе. В рамках от веста верности за продукт Innerspace отвечает только за телесные повреждения и тот материальный ущерб, который нанесен потребителю. Внесение изменений в предмет поставки, несоблюдение инструкции по монтажу, властности, указаний по технике безопасности, пренебрежение информацией продукте, использование неоригинальных или не рекомендованных Innerspace частей или использование не по назначению освобождают Innerspace от ответственности. В случае перепродажи или передачи другим покупателям покупатель обязуется перенести ограничение ответственности на следующих покупателей. Производитель оставляет за собой право на внесение технических изменений. Ответственность за опечатки или ошибки в наборе исключена.

SLOVENIAN

Garancija podjetja Innerspace je omejena na poškodbe, ki nastanejo na samem izdelku. Izrecno zavračamo odgovornost za implicitno predvidene implicitne lastnosti in obveznosti, predvsem tiste, ki se nanašajo na splošno uporabnost in primernost izdelka za določen namen. Istina odškodnine je omejena na višino kupcu dolžne vrednosti blaga. Vsaka druga odškodnina, zlasti nadomestilo za izgubljen dobiček, za posledično škodo itd. je izključena, razen v primeru povzročitve škode iz malomarnosti. Kupec je dolžan predložiti dokazila o nastali škodi. V okviru garancije za izdelke jamči podjetje Innerspace zgolj za telesne poškodbe in za materialno škodo, ki jo utрпи potrošnik. Podjetje Innerspace ne jamči v primeru: ko je prišlo na dostavljenem izdelku do sprememb, nastalih zaradi neupoštevanja navodil za montažo, še zlasti varnostnih navodil, ter če niso bile upoštrevane informacije o izdelku, če niso bili uporabljeni originalni deli, ali so bili uporabljeni deli, ki jih podjetje Innerspace ne priporoča, ali če je bil izdelek uporabljen v namene, ki niso v skladu z namenom uporabe izdelka. Kupec se zavezuje, da bo v primeru preprodaje ali prodaje izdelka drugi stranki, le-to opozoril na omejitve pri garanciji izdelka. Pridržujemo si pravico do tehničnih sprememb. Ne jamčimo za tiskarske napake.

ROMANIAN

Garania produsului Innerspace rămâne limitată numai asupra pagubelor care provin de la obiectele singulare ale produsului. Garania pentru proprietățile acceptate implicit și obligațiile, în special referitoare la întreținerea adecvată pentru un scop stabilit, sunt excluse categoric. Mărimea

despăgubirii este limitată la mărimea valorii mărfurilor datorate. Oricare alta despăgubire, în special compensația profitului pierdut, pagubele consecutive, etc., sunt excluse, numai dacă nu există o vină mare. Clientul are obligația dovezii (de a aduce argumente de învinuire). În cadrul garanției produsului, Innerspace garantează numai pentru pagube personale sau pentru pagubele lucrurilor pe care un consumator le îndură. Modificarea obiectelor livrate, nerespectarea instrucțiunilor de montaj și în special nerespectarea indiciașilor de siguranță, ne respecta informalelor produsului, folosirea de piese neoriginale sau nerecomandate de Innerspace, precum și folosirea cu destinație străină, scutește pe Innerspace de garanție. În cazul vânzării mai departe sau a predării, clientul se obligă să transmită viitorilor clienți limitarea garanției. Innerspace își păstrează dreptul la modificări. Nu este responsabil pentru greșeli de tipar sau greșeli de ortografie.

JAPANESE

損傷時、Innerspace は製品本体に係る損傷以外には責任を負いません。暗黙的に想定される特性や義務、とりわけ、特定目的の一般的な有用性や適合性に係る責任は、明示的に除外されています。請求金額は、顧客が支払う製品価額を上限とします。その他の請求、特に喪失利益にかかる補償や派生的損害賠償は、重過失の場合を除き、除外されています。立証責任は顧客側にあります。製品責任の枠組みの中で、Innerspace は、顧客個人のケガおよび顧客が被る重大な損害にのみ責任を負います。納品された物品に係る変更、とりわけ、安全上の指示等の組立説明事項の不順守、製品情報の不履行、非正規部品またはInnerspace が推奨しない部品の使用、本来とは異なる目的での使用については、Innerspace は一切の責任を免除されます。製品の再販売または移転にあたっては、顧客は責任制限を移行の顧客に承継させることを約束します。技術的変更が適用される場合があります。誤字については、Innerspace は責任を負いません。